

Comet WiFi

OPERATING INSTRUCTIONS



LEGAL NOTICE

Operating Instructions Comet WiFi Electronic Energy-Saving Controller

Manufacturer

EUROtronic Technology GmbH
Südweg 1
36396 Steinau-Ulmbach
Germany
www.eurotronic.org

Operating Instructions

Status 2025.12

Version 1.3 / EN

Publisher

Ingenieurbüro FORMAT GmbH
Ebertstraße 80
26382 Wilhelmshaven
Germany
www.format-docu.de

Legal Information

All brand names and trademarks mentioned in this document and, where applicable, protected by third-party rights, are subject without restriction to the provisions of the applicable trademark law and the ownership rights of the respective registered owners. Comply with all local and regional laws and regulations as well as the safety regulations referred to in this document.

Copyright Notice

The contents of this document are protected by copyright.

The disclosure, transfer and any other distribution of the contents of this document to third parties, the making of copies, transcripts and other reproductions as well as utilisation and any other use are prohibited - even in part - without the prior, express and written consent of the author.

© 2025 All rights reserved.

CONTENTS



These operating instructions will guide you through the commissioning and use of your Comet WiFi and answer all essential questions. Read these operating instructions carefully before using your Comet WiFi. Hand over all documents when passing it on to third parties.

1	Safety Information	4
1.1	Depiction of warnings	4
1.2	Warnings	5
2	Scope of Delivery	8
3	Overview	9
3.1	Proper use	9
4	Controls and Display Elements	10
5	Putting Comet WiFi into Operation	11
5.1	Installing Eurotronic Smart Living 2.0 app	11
5.2	Creating user account	12
5.3	Adding new device	13
5.4	Selecting network	14
5.5	Inserting batteries	15
5.6	Teaching in Comet WiFi	16
5.7	Installing on radiator	19
5.8	Adapter overview	21
5.9	Adapting Comet WiFi	23
5.10	Naming and assigning Comet WiFi	24
6	Removing Comet WiFi	26
7	Configuring App	27
7.1	Setting temperature in a room	28
7.2	Device settings	30
7.3	Heating profile	31
7.4	Holiday	35
7.5	Customer service	39
8	Operating Modes & Functions	41
8.1	Basic operating modes	41
8.2	Additional functions	42
8.3	Resetting to factory settings	44
9	Troubleshooting	45
10	Cleaning and Storage	46
11	Appendix	47
11.1	Technical data	47
11.2	Support and contact	47
11.3	Disposal	48
11.4	Personal data	49
11.5	Simplified declaration of conformity	49
11.6	Warranty notice	49
11.7	Manufacturer	49

1 SAFETY INFORMATION

In addition to the safety information in these operating instructions, all other available sources must also be observed.

The areas of use defined in the written explanations of the **proper use** must be observed.

1.1 DEPICTION OF WARNINGS

The warnings used in these operating instructions have the following meaning:



WARNING!

There is a risk of serious injury or even fatal injury if the warning sign containing this signal word is ignored.

→ Probability of occurrence: possible



CAUTION!

Moderate to minor personal injury may occur if warnings with this signal word are disregarded.

→ Probability of occurrence: possible



IMPORTANT!

Material damage can occur if warnings with this signal word are disregarded.

→ Probability of occurrence: possible



INFORMATION

Contains additional information.

1.2 WARNINGS

When operating your Comet WiFi and its components, hazards may occur that can be avoided by observing the following warnings.



WARNING!

Risk of fatal injury and accidents to infants and children!

There is a risk of suffocation from the device and packaging material.

- Never leave children unsupervised with the device or the packaging material. Children underestimate the risks involved. Always keep children away from the device and packaging material.
- Keep batteries out of reach of children. Should a battery be swallowed, seek medical attention immediately.



CAUTION!

Risk of injury through exploding or leaking batteries!

Improper handling of batteries can lead to an explosion.

- Only use batteries of the type specified.
- Never attempt to charge non-rechargeable batteries.
- Switch the device off and remove the batteries if the device will not be used for a longer period.
- Do not heat batteries and do not throw them into open flames or water.
- Do not place batteries in direct sunlight.
- Protect batteries from excessive heat.
- Do not short-circuit batteries.
- Never dismantle batteries.
- Do not use new and used batteries together.
- When inserting the batteries, observe the correct polarity (+/-).
- Before inserting the batteries, clean the batteries and the contacts in the device.
- Avoid contact of battery acid with skin, eyes and mucous membranes.
- In case of contact with battery acid, immediately rinse the affected areas with clean water and consult a doctor.
- Remove dead batteries from the device.
- Remove batteries from the device before disposing of the device.
- Improper handling of batteries can have adverse effects on your health and the environment. Batteries can contain toxic and environmentally harmful heavy metals (Cd = cadmium, Hg = mercury, Pb = lead). Therefore, separate disposal and recycling of used batteries is essential for environmental and health reasons.



CAUTION!

Burns caused by hot radiator valve!

Touching can cause burns to the hand.

- Allow the radiator to cool down before installing, disassembling or clearing faults on the device!
- Wear protective gloves



CAUTION!

Risk of injury due to malfunction!

Malfunctions can lead to injuries.

- Never carry out repairs to the device yourself.
- Do not open the device.
- Do not short-circuit the connection terminals of the device.
- Do not carry out any modifications or conversions on your device.
- Do not use the device if it is damaged.
- In the event of an error, contact Customer Service.



IMPORTANT!

Material damage and malfunction possible!

The device can be used by children from the age of 8 and persons with restricted physical, sensory or mental capabilities or a lack of experience and knowledge when they are supervised or if they have been instructed on safe use of the device and understand the potential dangers involved.

- Children must not be allowed to play with the device.
- Cleaning and user maintenance must not be carried out by children without supervision.



IMPORTANT!

Material damage and malfunction possible!

Environmental influences can affect the functions of the device.

- ➔ Keep the device away from direct sunlight.
- ➔ Only use the device in a dry, dust-free environment.
- ➔ Use only original accessories.
- ➔ Do not operate the device if it is damaged.



IMPORTANT!

Material damage and malfunction possible!

Damaged components and/or malfunctions prevent the device from working properly.

- ➔ If material damage and/or malfunctions occur, contact the Customer Service of Eurotronic Technology GmbH.

2 SCOPE OF DELIVERY

Check the scope of delivery for completeness as well as visual and technical defects before putting your Comet WiFi into operation.

- 1× Comet WiFi
- 1× Quick Guide
- 3× Adapter (Danfoss RA/RAV/RAVL)
- 1× Screw for adapter
- 2× AA/LR6 batteries
- 1× Reset button (only for older models)



IMPORTANT!

Material damage and malfunction possible!

Damaged components and/or malfunctions prevent the device from working properly.

→ If material damage and/or malfunctions occur, contact the Customer Service of Eurotronic Technology GmbH.



INFORMATION

The following drawings are for the purpose of illustration and are not necessarily to scale. EUROtronic Technology GmbH reserves the right to change the design or dimensions without prior notice.

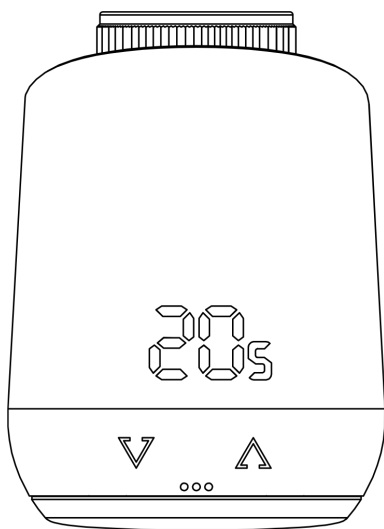

Comet WiFi energy-saving controller

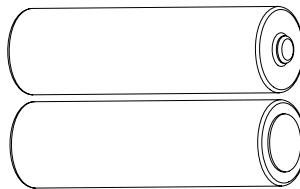

2× AA/LR6 batteries

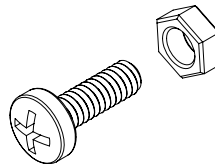

Screw
for adapter

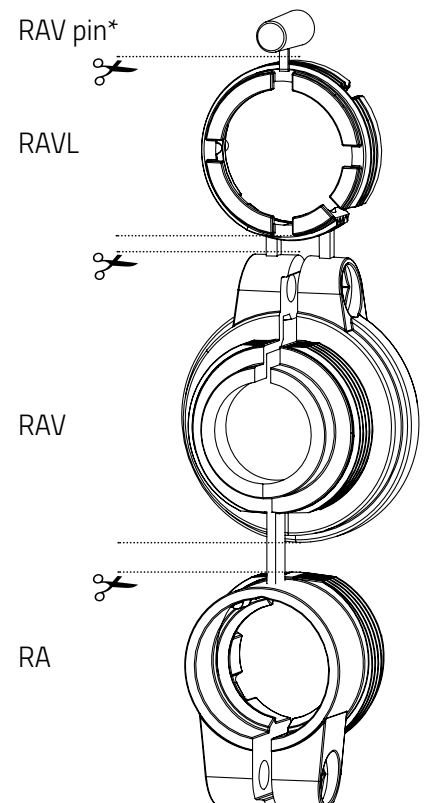

*When using the RAV adapter, the RAV pin is required to extend the valve plunger.

3 OVERVIEW

Thank you for choosing a product from EUROtronic Technology GmbH. Your Comet WiFi is an energy-saving controller for radiators equipped with the WiFi radio standard with modern, simple operation. It automatically regulates your room temperature according to your specifications and is configurable, either directly on the controller or conveniently with a smartphone via your WiFi network.

Your Comet WiFi helps you to effectively reduce your heating costs.

Development and production are 100% "Made in Germany", which guarantees premium quality and technology. These operating instructions will help you to get your Comet WiFi up and running quickly and easily.

3.1 PROPER USE

Your Comet WiFi is used to regulate a radiator valve. This makes it possible to regulate the room temperature time-controlled and via an app. Your Comet WiFi moves a radiator valve to control the flow of heat into the radiator. Your Comet WiFi can be installed on all common radiator valves. Only use your Comet WiFi indoors.

Any use other than that described in these operating instructions is not in accordance with the proper use and will result in the warranty being voided and exclusion of liability. It is forbidden to complete any unauthorised modifications, conversions and repairs. Your Comet WiFi is intended for private use only.



INFORMATION

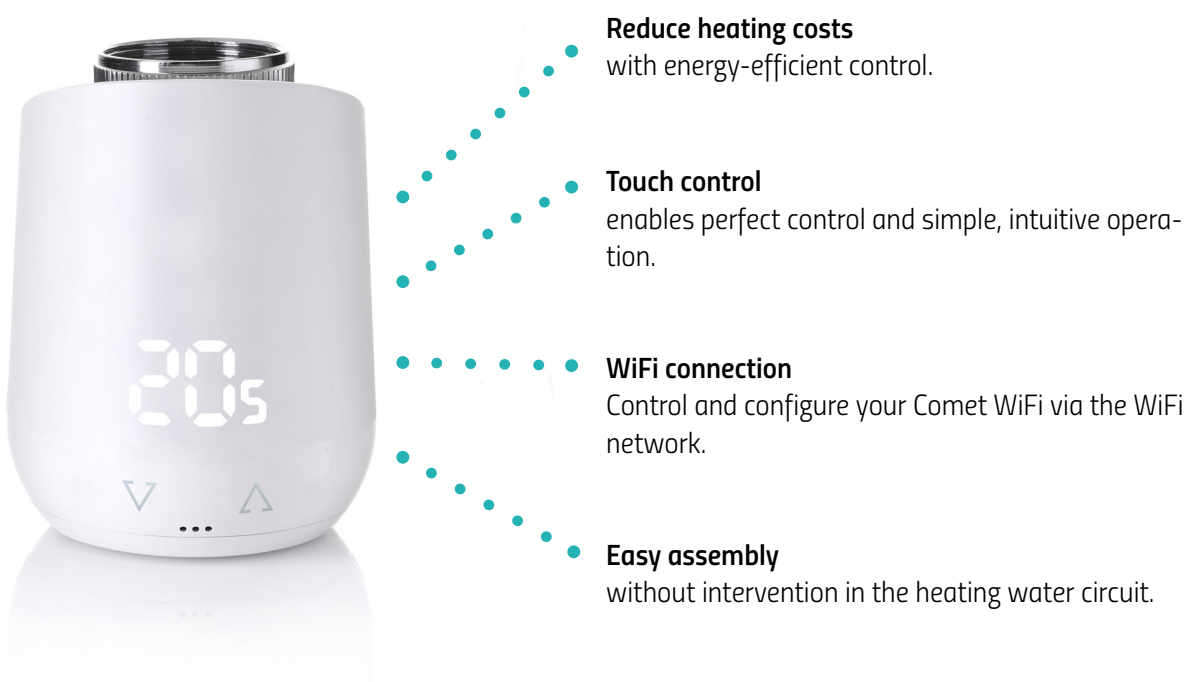

These instructions are valid for the Comet WiFi Model 1 and Comet WiFi Model 2 device types. The descriptions are based on the Comet WiFi Model 1 and are valid in most cases for the Comet WiFi Model 2. Deviations are indicated separately in the text.

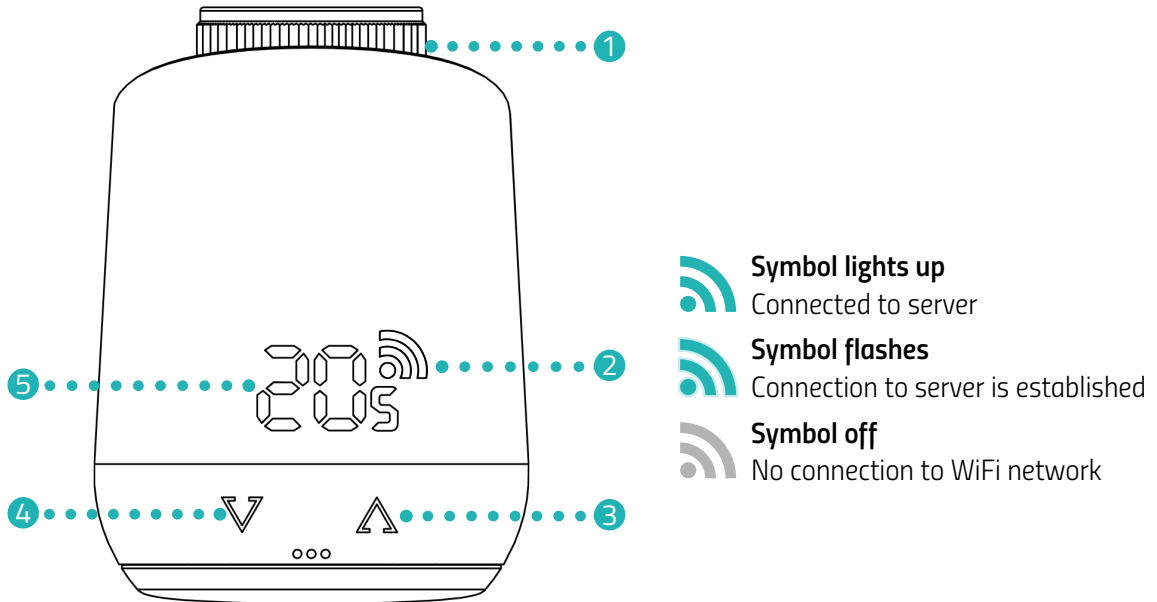

4 CONTROLS AND DISPLAY ELEMENTS

The following section describes the controls and display elements of your Comet WiFi.



-  **Symbol lights up**
Connected to server
-  **Symbol flashes**
Connection to server is established
-  **Symbol off**
No connection to WiFi network

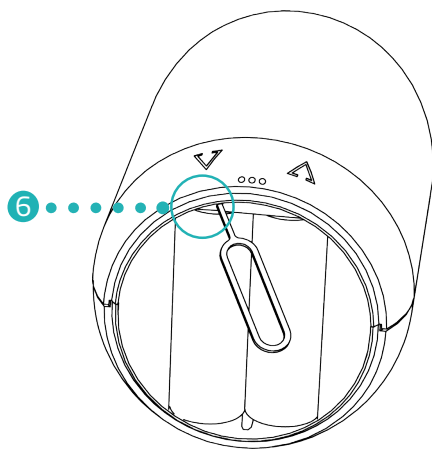

Comet WiFi Model 1

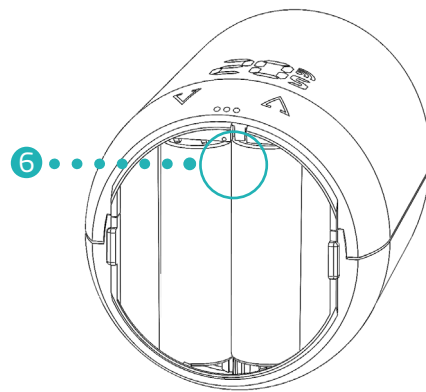

Comet WiFi Model 2

- 1 Union nut
- 2 Wireless symbol
- 3 Arrow button **Increase temperature**
- 4 Arrow button **Decrease temperature**
- 5 Temperature display
- 6 Reset button



INFORMATION

The first model series (Comet WiFi Model 1) has a recessed **reset button** that is operated with the reset key provided.

5 PUTTING COMET WIFI INTO OPERATION

The following section describes the procedure using the **Eurotronic Smart Living 2.0** app for the Android operating system (app version: 1.2). The procedure may differ for the iOS operating system.

Your Comet WiFi is also compatible with Alexa voice control.

You can find more information in the **Alexa Guide** at: <https://eurotronic.org/service/downloads/alexa/>



INFORMATION

The following illustrations show the app at the time of publication of these operating instructions. Newer versions of the app may differ in appearance and content.

5.1 INSTALLING EUROTTRONIC SMART LIVING 2.0 APP

1. Download the **Eurotronic Smart Living 2.0** app from Google Play (Android) or the App Store (iOS).
2. Install the app on your smartphone.

System requirements:

Android from version 6.0

iOS from version 13

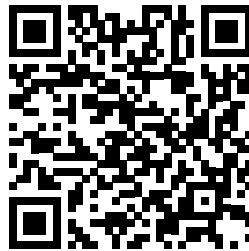

INFORMATION

During the initial setup of the app, requests are made as to whether the app is granted authorisation to access functions of your smartphone. Allow access to use the full range of functions of your Comet WiFi.

5.2 CREATING USER ACCOUNT

You must create a user account to use the app:

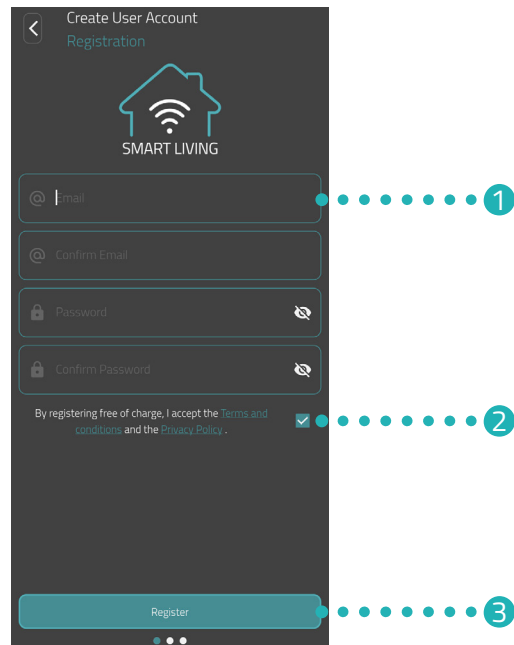

1. Create a user account. Enter your e-mail address and assign a password. Make sure your e-mail is valid. The validity of the e-mail address will not be checked.
2. Check the box to accept the general terms and conditions and data protection policy.
3. Tap the **Register** button.
 - ➔ You will receive an activation code by e-mail to verify your user account. Also check your spam folder.

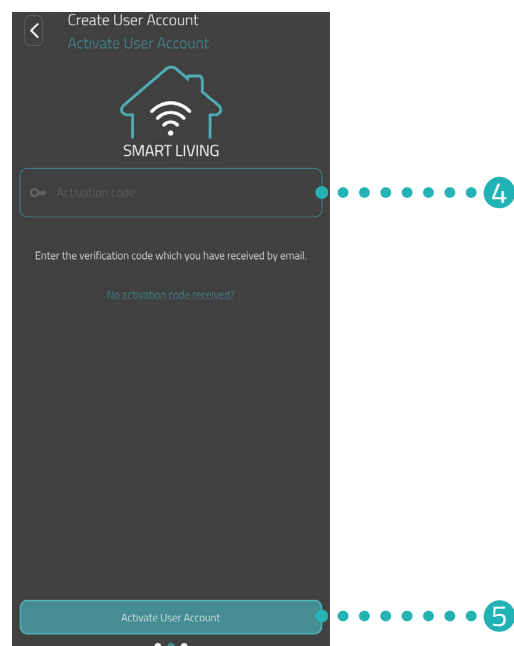

4. Enter the activation code in the **input field**.
5. Tap the **Activate User Account** button.
 - ➔ You have successfully created your user account.

5.3 ADDING NEW DEVICE



1. Tap the + button to add a new device.
2. Then follow the steps displayed in the setup wizard to set up your Comet WiFi for initial operation.
→ You have successfully added your Comet WiFi.

5.4 SELECTING NETWORK

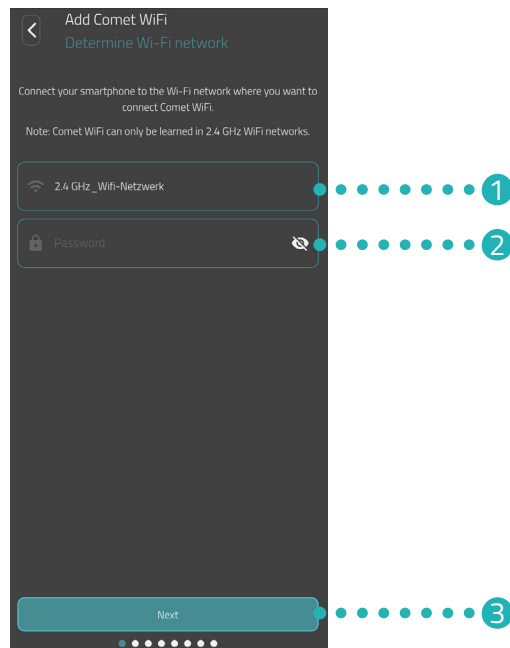

1. The WiFi network to which your smartphone is connected is automatically displayed. You can integrate your Comet WiFi in another WiFi network if required.



INFORMATION

For your WiFi to be displayed in the **My WiFi Network** field, the following requirements must be met:

- Your WiFi must transmit in the 2.4 GHz frequency range. If your router only supports the 5 GHz frequency range, operation of your Comet WiFi is not possible. For more information, see the operating instructions for your router.
- The location detection (GPS) of your smartphone must be activated.
- The **Eurotronic Smart Living 2.0** app requires authorisation to access your location (GPS). Adjust this setting in your smartphone if necessary. For more information, see the operating instructions for your smartphone.

2. Enter your WiFi password in the input field. Make sure you spell your password correctly. The app will not check your WiFi's password. If the password is entered incorrectly, the setup process will still continue, but the connection to your Comet WiFi cannot be established.
3. Tap the **Next** button.
 - ➔ You have successfully connected your Comet WiFi to your WiFi network.

5.5 INSERTING BATTERIES

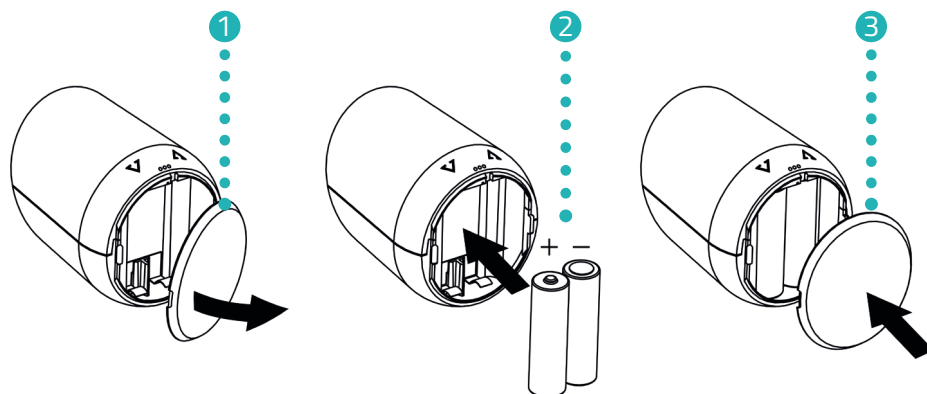
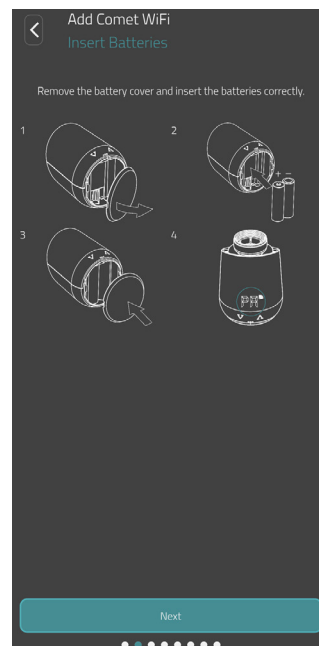

1. Open the battery compartment cover.
2. Insert the batteries provided as shown.
Pay attention to the correct polarity and do not use rechargeable batteries!
3. Close the battery compartment cover. The battery compartment cover audibly clicks into place.
→ You have successfully inserted the batteries.

5.6 TEACHING IN COMET WIFI

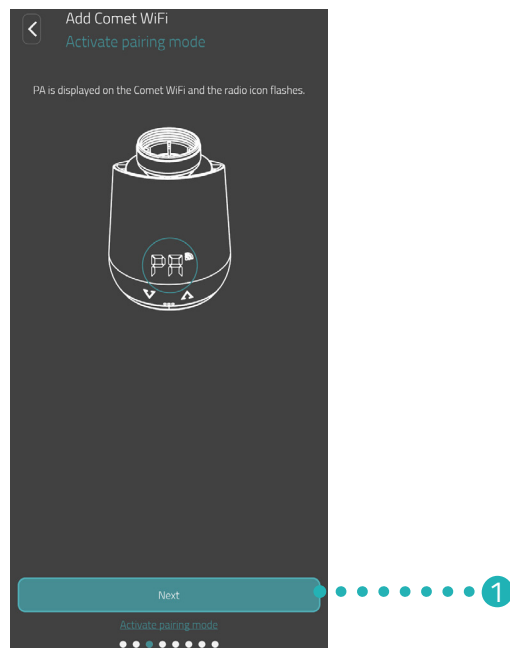

PA appears on the display of your Comet WiFi and the wireless symbol flashes. Your Comet WiFi is ready to connect to your WiFi network.

1. Tap the **Next** button.

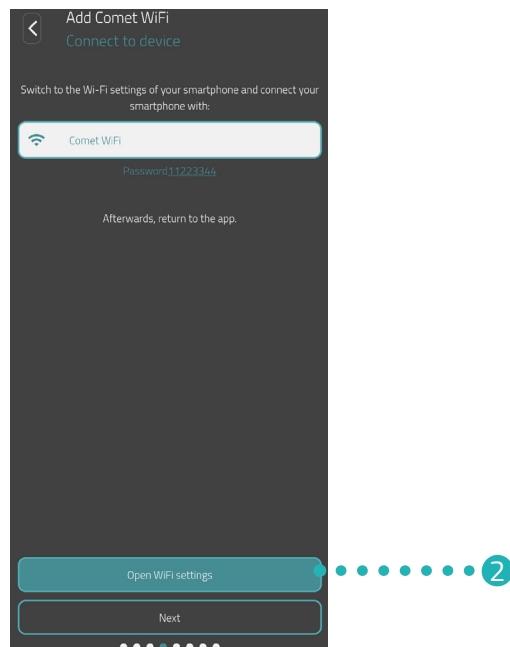

2. Tap the **Open WiFi Settings** button to switch to the WiFi settings of your smartphone.

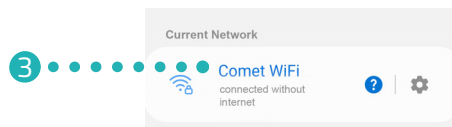

3. Select your Comet WiFi in the WiFi settings of your smartphone. Depending on the software version, your Comet WiFi is displayed in the WiFi settings with the designation "Comet WiFi" or "Eurotronic".
4. When prompted, enter the password displayed in the app (from factory 11223344) in the input field to connect to your Comet WiFi.
 - A loading animation appears on the display of your Comet WiFi.
 - Your Comet WiFi is connected to your WiFi and the app. The process may take a moment.



INFORMATION

During setup, you are briefly connected to the WiFi network of your Comet WiFi and a message may be displayed informing you that you are not connected to the Internet. Confirm this message to stay connected to your Comet WiFi and continue with the setup.

5. Switch back to the **Eurotronic Smart Living 2.0** app.

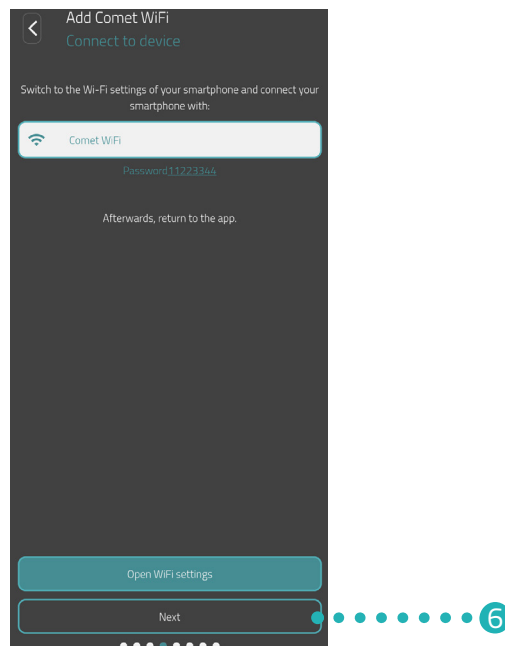

6. Tap the **Next** button.



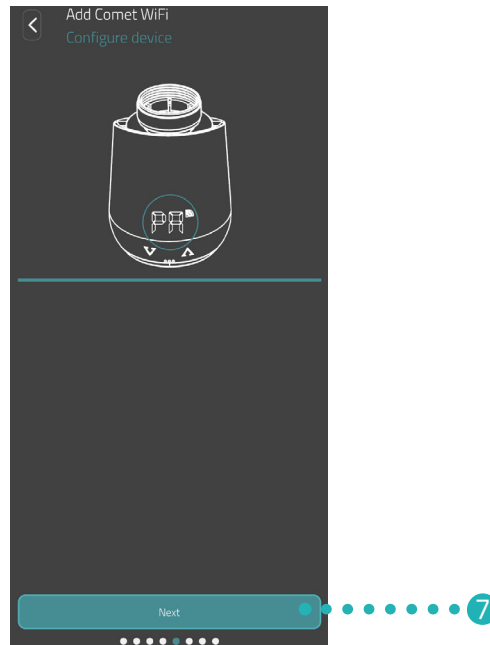

INFORMATION

If you are using a Comet WiFi with an older software version, a software update will automatically be carried out after the setup.

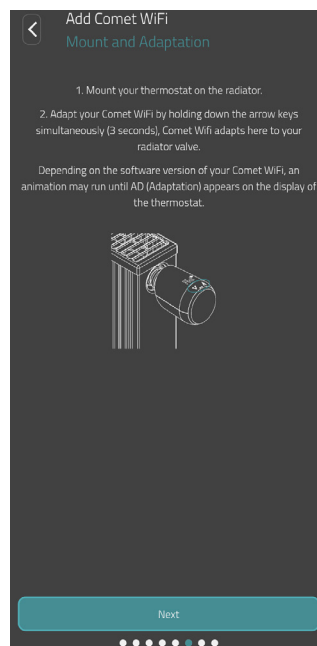

7. Tap the **Next** button.



8. Now install your Comet WiFi on your radiator (see  Section 5.7 Installing on radiator on Page 19) and tap the **Next** button.



INFORMATION

If the setup is not completed, ensure the following points:

- Temporarily deactivate the mobile data of your smartphone.
- Activate the location detection (GPS) of your smartphone and allow the app to access it.

5.7 INSTALLING ON RADIATOR

Install your Comet WiFi on the desired radiator when indicated by the app.

The Comet WiFi can be installed on all known valve bodies (see adapter list at www.eurotronic.org/service/faq).



CAUTION!

Burns caused by hot radiator valve!

Touching can cause burns to the hand.

- ➔ Do not touch hot radiator valves!
- ➔ Allow the radiator to cool down before installing, disassembling or clearing faults on the device!

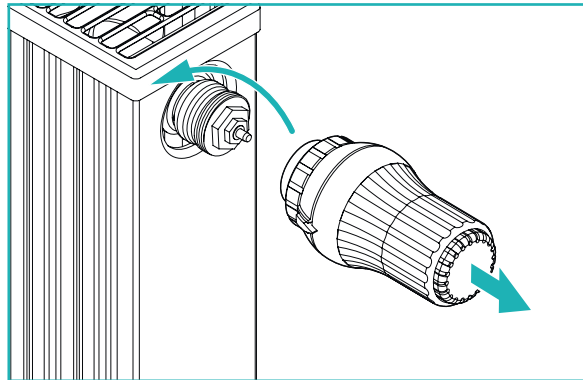

1. Open the current thermostatic head completely. Loosen the fastening and pull the thermostatic head off the radiator.

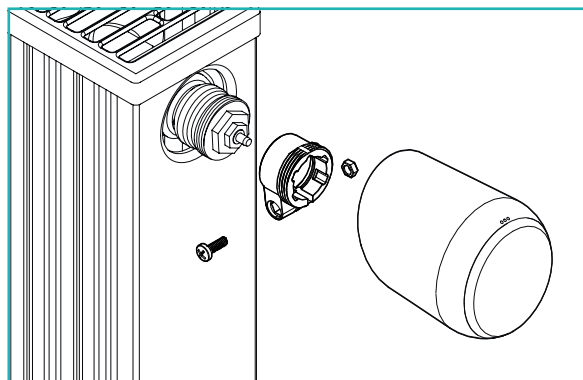

2. Optional: Select a suitable adapter from the scope of delivery. For additional information on the adapters, please see the  Section **Comet WiFi Model 2 on Page 10**.

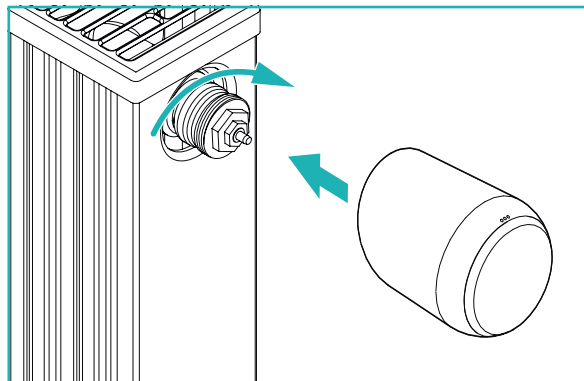

3. Position your Comet WiFi on the radiator and turn the union nut clockwise.
 - ➔ You have successfully installed your Comet WiFi.
 - ➔ Following installation, start the adaptation, see  Section **Comet WiFi Model 2 on Page 10**.



INFORMATION

When installing/removing at a later date, please note that your Comet WiFi must be in the adaptation mode. To do this, open the battery compartment cover and remove the batteries. Replace the batteries after approx. 10 sec. and close the battery compartment cover. Your Comet WiFi restarts and is in the adaptation mode. **Ad** appears in the display.

5.8 ADAPTER OVERVIEW

The following overview contains information about the valves and the required adapters. The adapters for Danfoss RAV, Danfoss RA and Danfoss RAVL are included with your Comet WiFi. When using the Danfoss RAV adapter, the RAV pin must be inserted on the valve plunger.

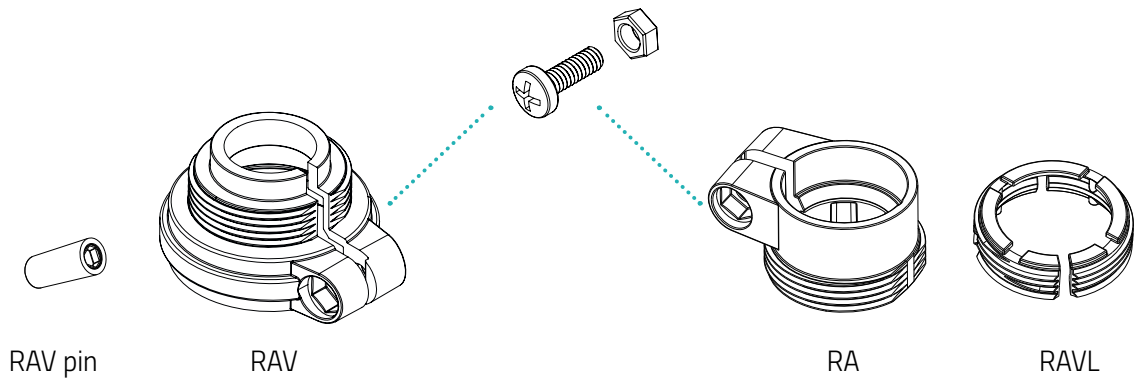

Valve	Thread dimension	Adapter
Heimeier	M30 x 1.5 mm	Not required
Junkers Landys+Gyr	M30 x 1.5 mm	Not required
MNG	M30 x 1.5 mm	Not required
Honeywell	M30 x 1.5 mm	Not required
Braukmann	M30 x 1.5 mm	Not required
Herz	M28 x 1.5 mm	Required; not in scope of delivery
Comap	M28 x 1.5 mm	Required; not in scope of delivery
Vaillant	30.5 mm	Required; not in scope of delivery
Oventrop	M30 x 1.0 mm	Required; not in scope of delivery
Meges	M38 x 1.5 mm	Required; not in scope of delivery
Ondal	M38 x 1.5 mm	Required; not in scope of delivery
Giacomini	22.6 mm	Required; not in scope of delivery
Rosswainer	M33 x 2.0 mm	Required; not in scope of delivery
Markaryd	M28 x 1.0 mm	Required; not in scope of delivery
Ista	M32 x 1.0 mm	Required; not in scope of delivery
Vama	M28 x 1.0 mm	Required; not in scope of delivery
Pettinaroli	M28 x 1.5 mm	Required; not in scope of delivery
T+A	M28 x 1.5 mm	Required; not in scope of delivery
Gampper 1/2/6	M20	Required; not in scope of delivery
Danfoss RA/RAV/RAVL	25.5/30.5/30 mm	Included in scope of delivery



INFORMATION

Remove the connecting pieces of the plastic adapters completely (see illustration) before using one of the adapters included! For Danfoss RAV and Danfoss RA, use the screw and nut provided.

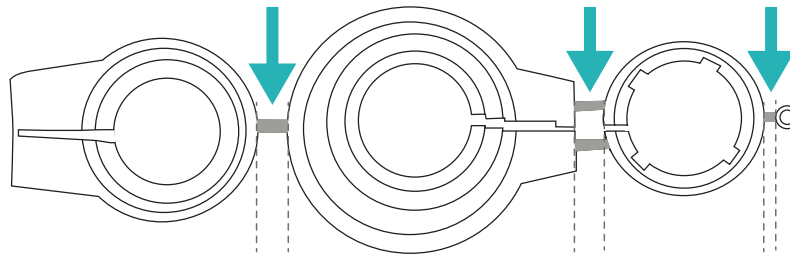

CAUTION!

Danger of being cut!

The adapters supplied and the plunger extension are connected by plastic bars. Fractures may be sharp-edged.

→ Be careful not to cut your fingers during installation!



CAUTION!

Danger of becoming trapped between the adapter halves!

Carelessness when using adapters can lead to injuries.

→ Take care not to become trapped between the adapter halves during installation!

You can purchase further metal adapters for a fee from our partners. You will find an overview of the metal adapters and corresponding ordering options under the following link:

<https://eurotronic.org/produkte/zubehoer/metalladapter/>

5.9 ADAPTING COMET WiFi

After successful assembly, your Comet WiFi can start adapting. The prerequisite is that **Ad** is shown in the display of your Comet WiFi.

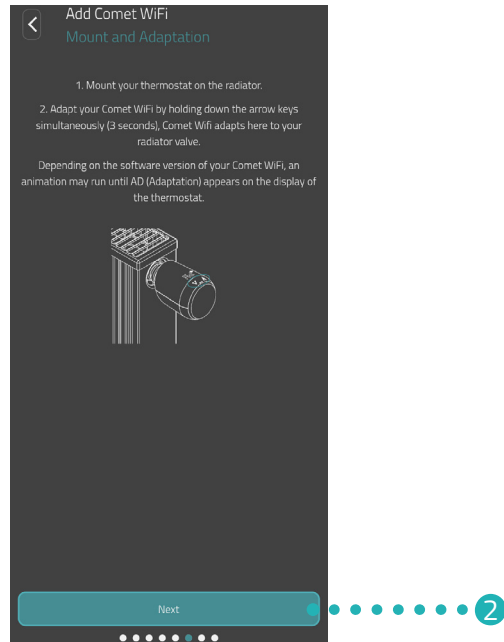

1. To start the adaptation, press and hold both **arrow buttons** on your Comet WiFi simultaneously for approx. 3 seconds.
 - ➔ When adapting, your Comet WiFi adapts to the stroke of your lower valve section. For this purpose, the valve is opened and closed several times to detect the respective end points. The process may take a moment. After successful adaptation, your Comet WiFi switches to normal operation.
2. Tap the **Next** button in the app.

If a problem occurs with your Comet WiFi, a new adaptation is necessary. Carry out the following steps for this purpose:

1. Open the battery compartment cover.
2. Press the **reset button**. For Comet WiFi Model 1, use the reset key included in the scope of delivery.
 - ➔ A timer in the display runs up to **10**. Then **PA** is displayed and the WiFi symbol flashes.
3. Alternatively, remove the batteries and wait for 10 seconds. Then reinsert the batteries.
4. Close the battery compartment cover.
 - ➔ Your Comet WiFi restarts and is then in the adaptation mode. **Ad** appears in the display.



INFORMATION

Your Comet WiFi must be re-adapted after each battery change.

5.10 NAMING AND ASSIGNING COMET WiFi

After successful installation and adaptation, you can give your Comet WiFi a name in the app and assign your Comet WiFi to a room.

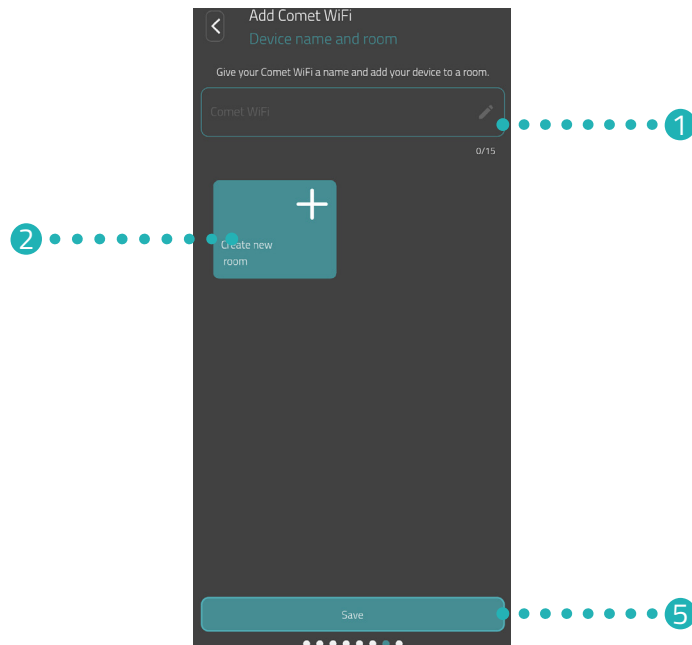

1. Enter a designation for your Comet WiFi in the input field.
2. Tap the **Create new room** button to create a room and assign your Comet WiFi to this room.



INFORMATION

When using several Comet WiFi, you can also assign the devices to existing rooms. It is not necessary to create a separate room for each Comet WiFi.

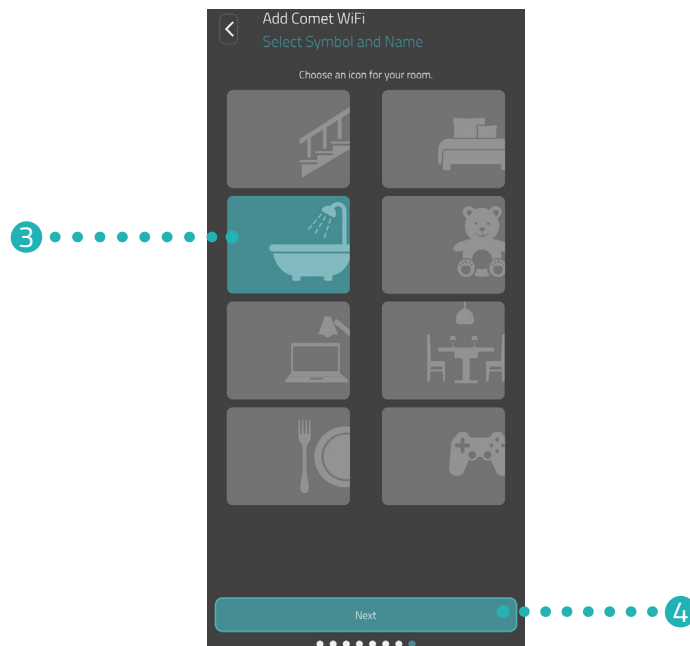

3. Select a symbol and a name for the room.
4. Tap the **Next** button.
5. Tap the **Save** button.
 - You have successfully named your Comet WiFi and assigned it to a room.
 - Your Comet WiFi is now fully set up and ready to use.



INFORMATION

If problems occur during the saving process, your smartphone may not be connected to the correct WiFi. In the WiFi settings, make sure that your smartphone is connected to the correct WiFi (2.4 GHz). Then repeat the saving process.

6 REMOVING COMET WIFI

The prerequisite for removing your Comet WiFi is that your Comet WiFi is in the adaptation mode, see  Section **Comet WiFi Model 2 on Page 10**.

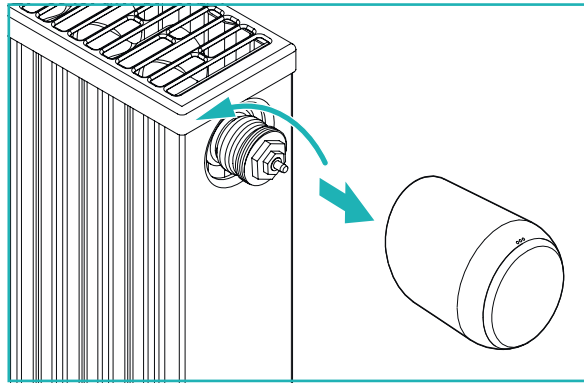

CAUTION!

Burns caused by hot radiator valve!

Touching can cause burns to the hand.

- ➔ Do not touch hot radiator valves!
- ➔ Allow the radiator to cool down before installing, disassembling or clearing faults on the device!

1. Turn the union nut anti-clockwise.
2. Pull your Comet WiFi off the valve (see illustration).
 - ➔ You have removed your Comet WiFi.

7 CONFIGURING APP

After successful installation and initial start-up of your Comet WiFi, you can make further settings in the **Eurotronic Smart Living 2.0** app.

From the start screen (My Home) you have access to the menu bar and all the rooms that have been set up.

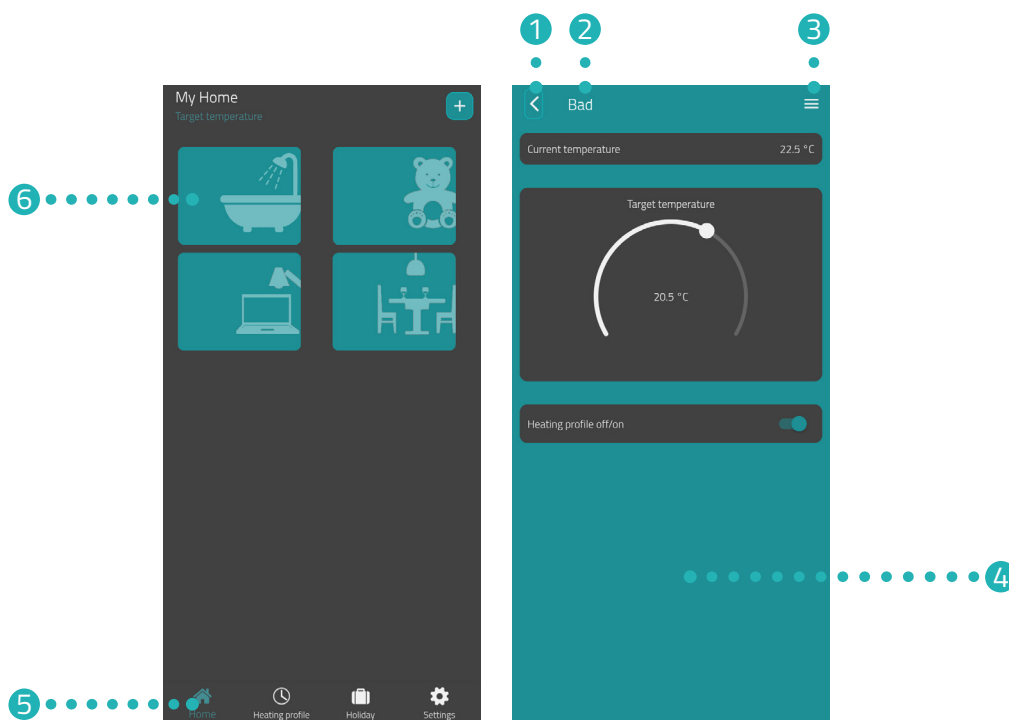

- | | |
|-----------------|---|
| ① Back button | ④ Current display (e.g. room, device, etc.) |
| ② Selected room | ⑤ Menu bar |
| ③ Room menu | ⑥ Selection of rooms |

Via the selection of rooms, you have access to the associated Comet WiFi devices.

The following functions are available in the menu bar:

- Home screen (My Home)
- Heating plans, see Section **7.3 Heating profile on Page 31**
- Holidays, see Section **7.4 Holiday on Page 35**
- Settings, see Section **7.5 Customer service on Page 39**

7.1 SETTING TEMPERATURE IN A ROOM

You can set the temperature for each room individually. After selecting a room, set the desired temperature for the room or radiator.

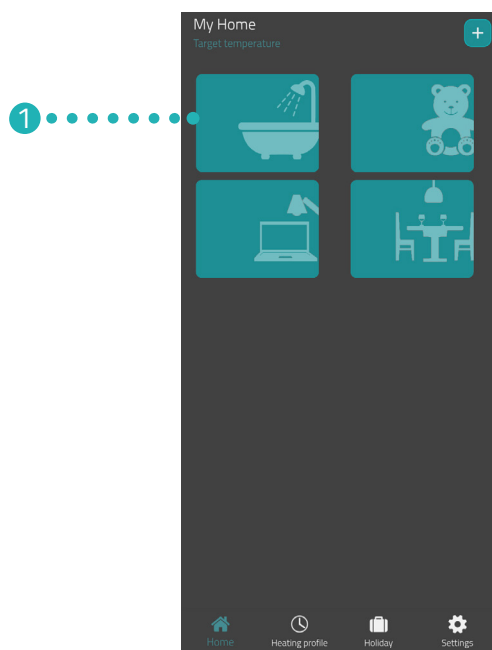

1. Tap on the desired room (e.g. bathroom).
→ The current room temperature and the set temperature are displayed.

2. Make additional settings:



- ① The menu displays all Comet WiFis that are assigned to the current room. You can make additional settings for the selected Comet WiFi, see  Section **7.2 Device settings on Page 30**.
- ② The **Current temperature** area displays the current temperature in the room.
- ③ Adjust the temperature individually with the setting wheel in the **Set Temperature** area.

- ④ **Heating profile off:**
The stored heating profile is not active.
Heating profile on:
The stored heating profile is active. However, you can still make changes to the temperature. The temperature set manually is maintained until the next switching point. Your Comet WiFi then switches to the set heating program.

7.2 DEVICE SETTINGS

In the menu of a room (see  Section **7.1 Setting temperature in a room on Page 28.**) you have access to all Comet WiFi's assigned to the room. You have access to additional settings and information about the selected Comet WiFi:

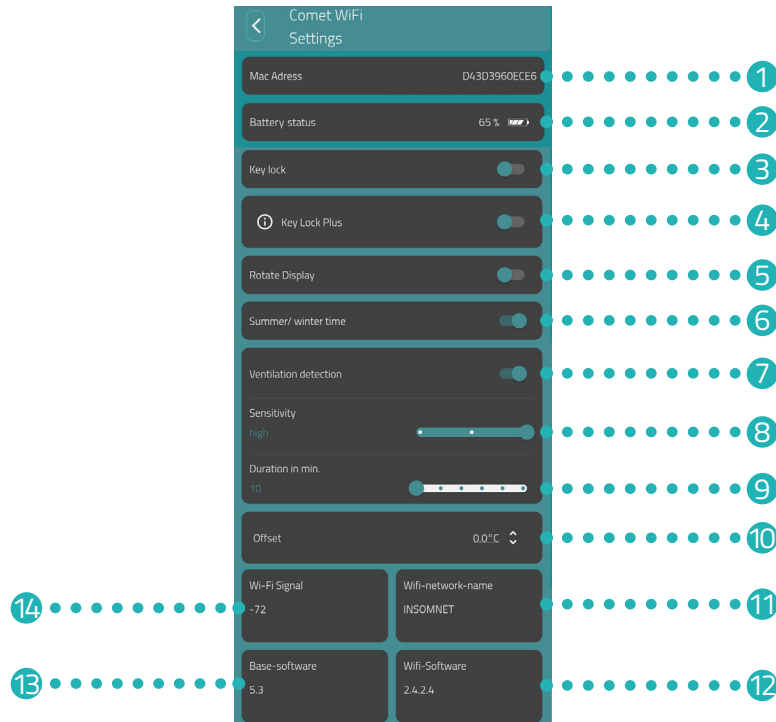

- 1 Mac address.
- 2 Current battery level
- 3 Activate/deactivate key lock
- 4 Activate/deactivate key lock Plus
- 5 Rotate display 180°
- 6 Summer/winter time is changed automatically (activated at factory)
- 7 Activate/deactivate ventilation detection.
- 8 Sensitivity of ventilation detection
- 9 Duration for which the heating valve is closed when ventilation detection is activated
- 10 Carry out temperature adjustment
- 11 Currently connected WiFi network.
- 12 Version of the current WiFi software.
- 13 Version of current controller software.
- 14 Signal strength of connected WiFi.



INFORMATION

Not all the functions shown are activated by default.

For additional information on the functions listed above, see  Section **8.2 Additional functions on Page 42.**

7.3 HEATING PROFILE

In the **Heating profile** menu, you set heating blocks with heating times for different days. You can set the temperature individually for each heating time.

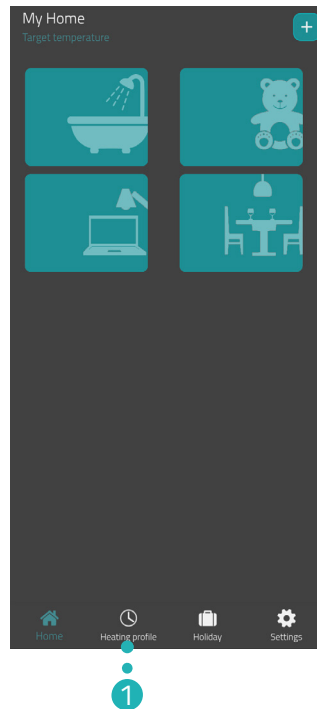

1. Tap the **Heating profile** button.
→ The overview of the heating profiles is displayed.

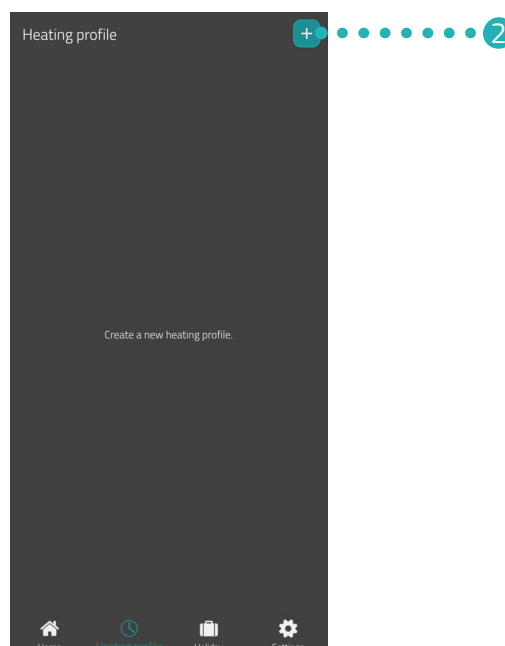

2. Tap the **+** button to create a new heating profiles.
→ The overview of the available rooms is displayed.

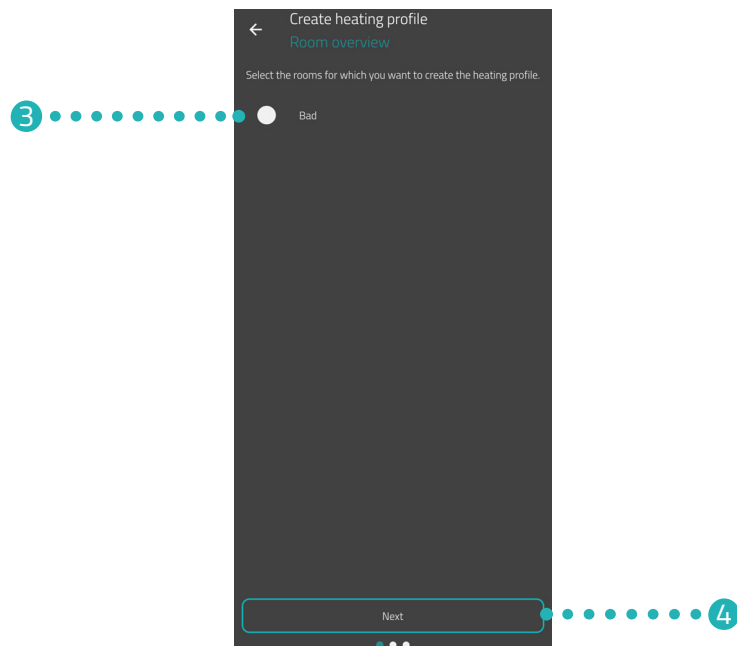

3. Tap on one or more rooms for which the heating profiles is to apply.
4. Tap the **Next** button.

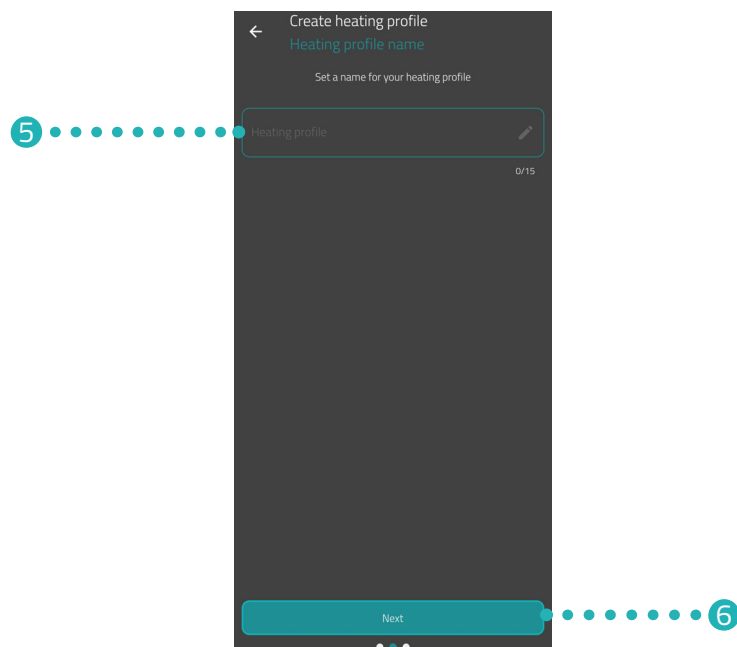

5. Enter a designation for the heating profiles in the input field.
6. Tap the **Next** button.

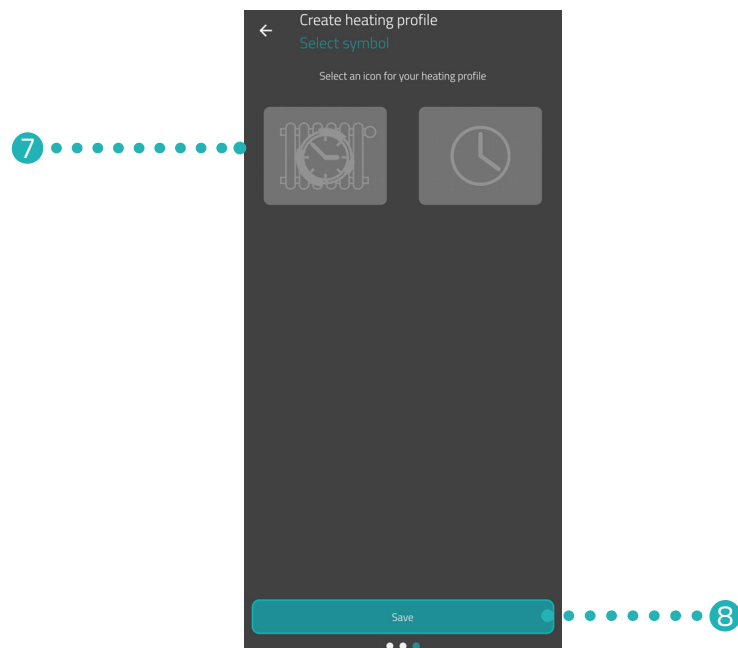

7. Select a symbol for the heating profile.
8. Tap the **Save** button.
 - ➔ You have successfully created the heating profile.



9. Tap the **heating profile** to set the heating times:

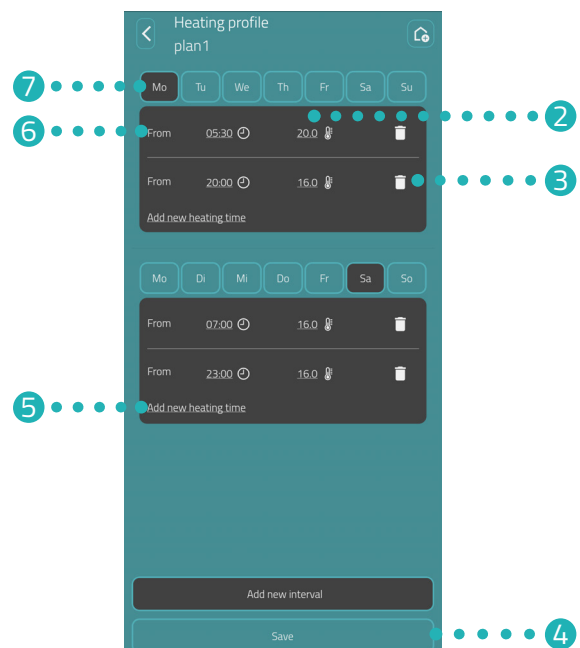
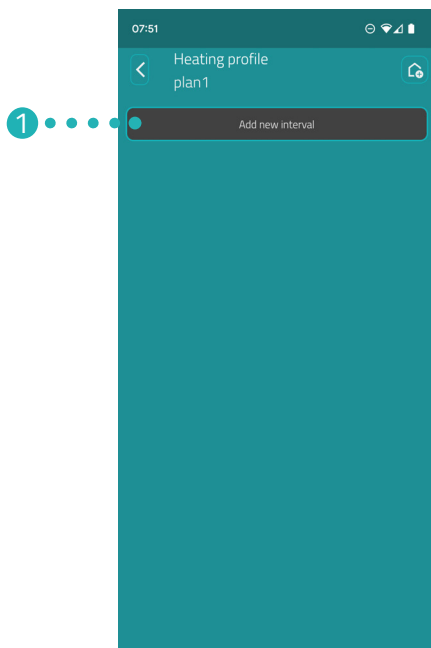

- ① Add a new heating block.
- ② Set the target temperature for the selected switching point.
- ③ Delete the selected heating time.
- ④ Save the settings.
- ⑤ Add a new heating time for the heating block.
- ⑥ Set the starting time of the selected heating time.
- ⑦ Select the period of the current heating block.



INFORMATION

Note that the settings are only transferred to the corresponding Comet WiFi and are consequently activated by tapping the **Save** button.

7.4 HOLIDAY

Set a holiday profile for a period of absence in the **Holiday** menu. You can set the temperature individually for each switching point.

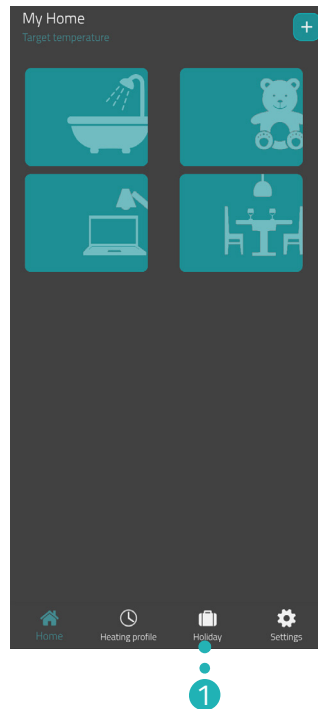

1. Tap the **Holiday** button.
2. Tap the **+** button to create a new holiday profile.
→ The overview of the available rooms is displayed.

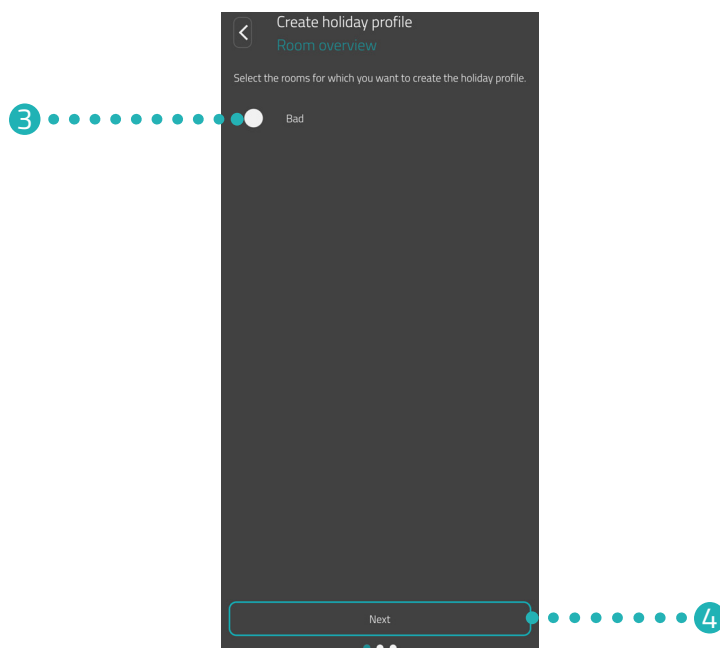

3. Tap on one or more rooms for which the holiday profile is to apply.
4. Tap the **Next** button.

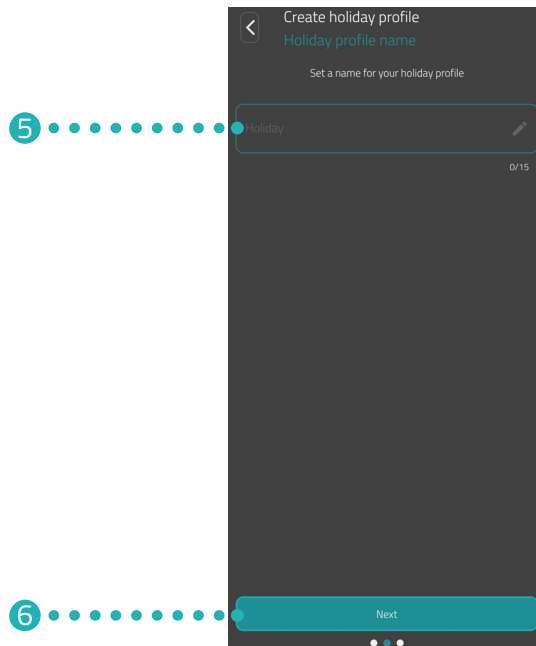

- 5. Enter a designation for the holiday profile in the input field.
- 6. Tap the **Next** button.

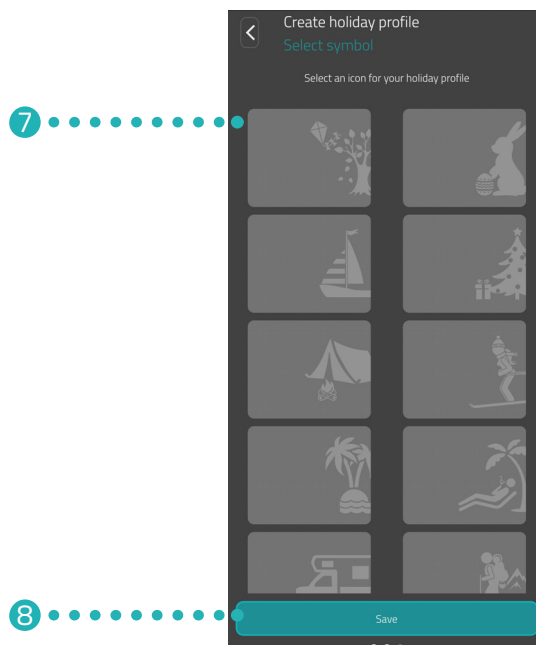

- 7. Select a symbol for the holiday profile.
- 8. Tap the **Save** button.

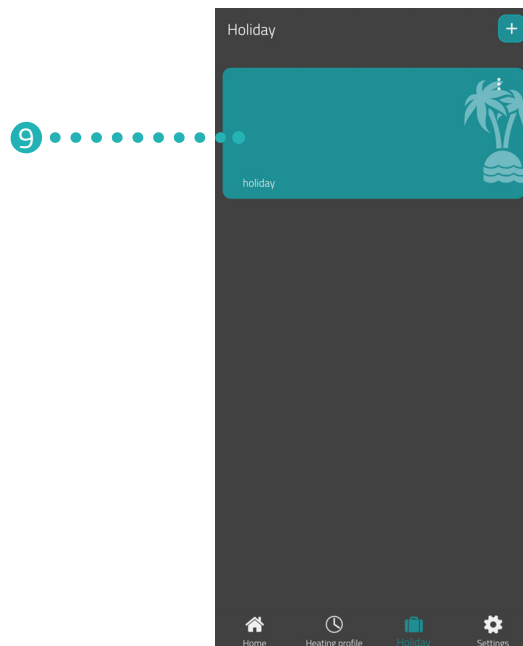

9. Tap **Holidays** to set the heating times:
→ You have created the heating profile for a period of absence.

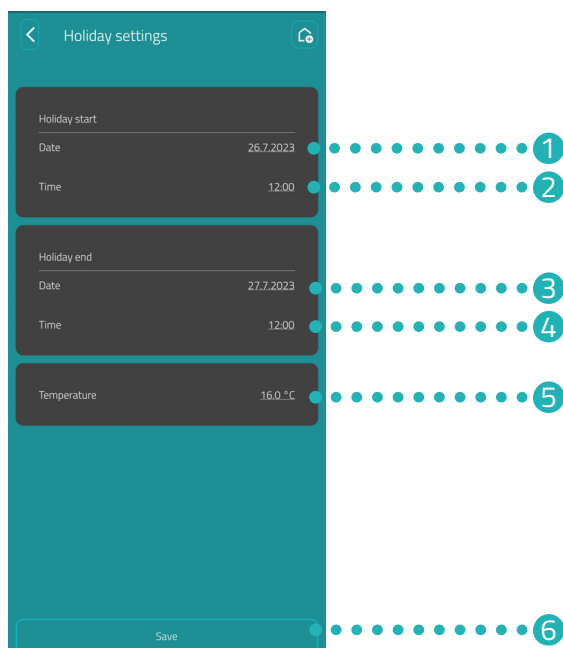

- 1 Set the **Date** for the start of the period of absence.
- 2 Set the **Time** for the beginning of the period of absence.
- 3 Set the **Date** for the end of the period of absence.
- 4 Set the **Time** for the end of the period of absence.
- 5 Set the **Temperature** for the period of absence.
- 6 Save the settings.



INFORMATION

Note that the settings are only transferred to the corresponding Comet WiFi and are consequently activated by tapping the **Save** button.

7.5 CUSTOMER SERVICE

The following section describes the Customer Service area in the **Eurotronic Smart Living 2.0** app.

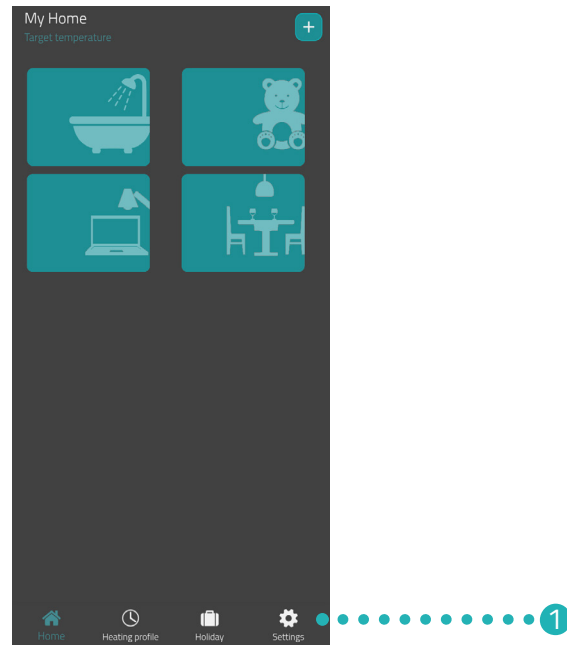

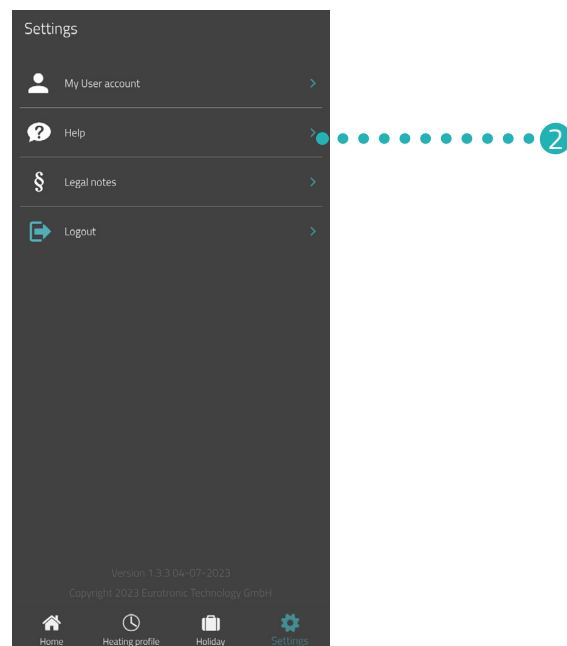

1. Tap the **Settings** button on the My Home screen.

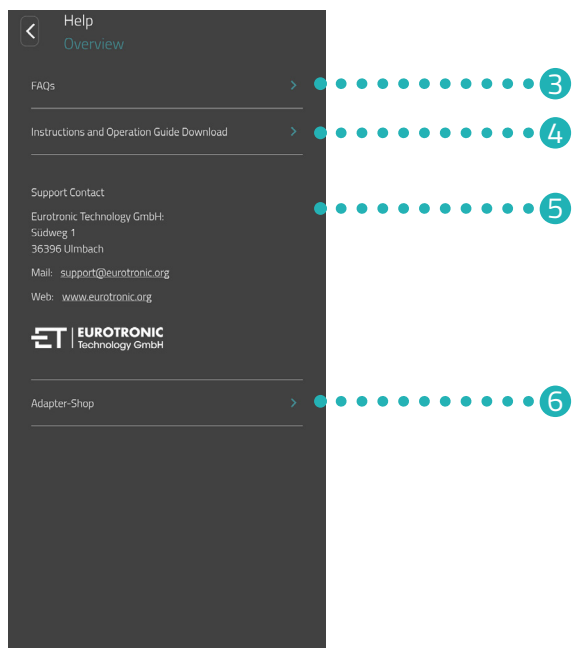

2. Tap the **Help** button.



3. Tap the **FAQs** button to open the "Frequently Asked Questions" website.
4. Tap the **Instructions and Operating Guide Download** button to download the operating instructions for the **Eurotronic Smart Living 2.0** app.
5. This area displays the contact information (see  Section **11.2 Support and contact on Page 47**).
6. Tap the **Adapter Shop** button to open the website with more adapters (see  section **5.8 Adapter overview on Page 21**).

8 OPERATING MODES & FUNCTIONS

The following section describes the operating modes and other functions of your Comet WiFi.

8.1 BASIC OPERATING MODES

HEATING PROFILE (ACTIVATED)

If you activate the heating profile in the **Eurotronic Smart Living 2.0** app, your Comet WiFi regulates the temperature according to the set heating profile. You can still make changes to the temperature (in the **Eurotronic Smart Living 2.0** app or on your Comet WiFi) at any time. The manually set temperature remains unchanged until the next heating time. Your Comet WiFi then switches back to the set heating profile.

HEATING PROFILE (DEACTIVATED)

If you deactivate the heating profile in the **Eurotronic Smart Living 2.0** app, your Comet WiFi adjusts to the manually set temperature. The temperatures are not changed at the set heating time.

HOLIDAY

You can set a freely selectable temperature for the time you are absent. After the set time has elapsed, the heating profile set by you runs again automatically. To set the holiday, select the **Holiday** menu item in the **Eurotronic Smart Living 2.0** app, see  Section 7.4 **Holiday on Page 35**.

If you press a button on the Comet WiFi during an active holiday profile, **Ho** appears in the display. When a button is pressed again, the set temperature is shown on the display, thereby deactivating the holiday profile.

HEATING PROFILE

You can easily and conveniently set your heating profile in the **Eurotronic Smart Living 2.0** app under the menu item **Heating profiles**, see  Section 7.3 **Heating profile on Page 31**.

MANUAL OPERATION

It is possible to change the temperature manually using the touch buttons on your Comet WiFi. If a heating profile is activated, this manually set temperature remains set until the next heating time. Your Comet WiFi then switches back to the set heating profile.

8.2 ADDITIONAL FUNCTIONS

VENTILATION DETECTION

If the temperature drops sharply due to an open window, your Comet WiFi automatically closes the heating valve to save energy. You can activate and deactivate the **window-open detection** function in the **Eurotronic Smart Living 2.0** app. Adjust the settings if necessary, see  Section **7.2 Device settings on Page 30**.



INFORMATION

Depending on the installation situation of your Comet WiFi and the set sensitivity, the open window may not be detected. A tilted window may not be detected if the temperature drop is not sufficient. Adjust the settings if necessary, see  Section **7.2 Device settings on Page 30**.

OFFSET (TEMPERATURE ADJUSTMENT)

If the temperature felt differs from the set temperature, you can perform a temperature adjustment. Adjust the settings if necessary, see  Section **7.2 Device settings on Page 30**.

ALIGN DISPLAY

Depending on the positioning of your radiator valve, it may be necessary to turn the display of your Comet WiFi by 180°. Adjust the settings if necessary, see  Section **7.2 Device settings on Page 30**.

KEY LOCK / KEY LOCK PLUS

Activate the key lock in the **Eurotronic Smart Living 2.0** app to lock your Comet WiFi for other people, see  Section **7.2 Device settings on Page 30**.

Alternatively, activate the key lock directly on your Comet WiFi:

1. Press and hold both **arrow buttons** for a few seconds. A corresponding animation is shown on the display.
2. To deactivate, press and hold both **arrow buttons** for a few seconds. Wait until the animation on the display disappears.



INFORMATION

The Key Lock Plus can only be deactivated using the App and not using the arrow buttons on your Comet WiFi.

FROST AND LIME PROTECTION

The frost protection and limescale protection functions are automatically active.

Frost protection: If the temperature drops below 8° C, the display shows --. In this case, your Comet WiFi opens the valve until the temperature rises above 8° C again. This prevents the radiators from freezing.

Lime protection: To prevent the radiator valves from calcifying, your Comet WiFi performs a limescale protection run every Friday at 11:00.

TRAINING MODE

On older models of the Comet WiFi (Comet WiFi Model 1), press the lower **reset button** in the battery compartment once. The display shows **PA** Additional information see  Section **5.3 Adding new device** on **Page 13**.

8.3 RESETTING TO FACTORY SETTINGS

If problems occur, it may be helpful to reset your Comet WiFi to the factory settings.

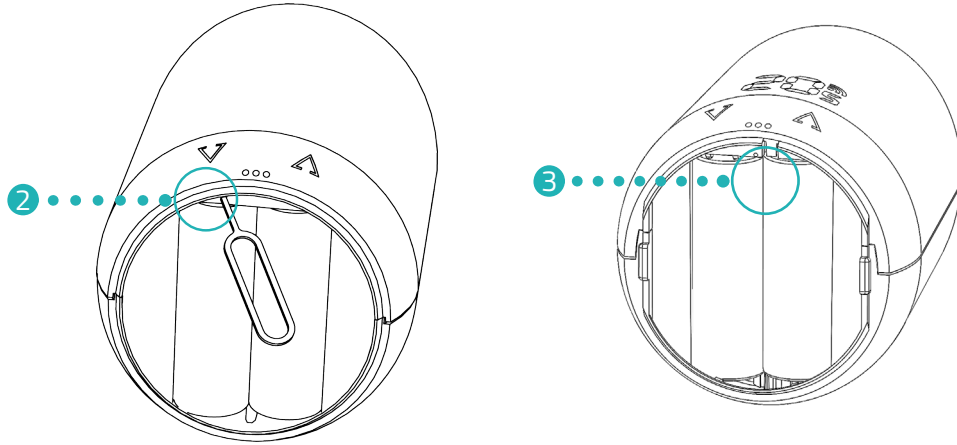

1. Open the battery compartment cover.
2. **Comet WiFi Model 1:** Press the lower **reset button** in the battery compartment once. Use the reset key included in the scope of delivery.
 - ➔ A timer in the display runs up to **10**. Then **PA** is displayed and the WiFi symbol flashes.
 - ➔ You have reset your Comet WiFi to the factory settings. Perform the initial setup again, see  Section **5.3 Adding new device on Page 13**.



INFORMATION

If your Comet WiFi still has an older firmware version, no timer is shown in the display.

3. **Comet WiFi Model 2:** Press and hold the **reset button** in the battery compartment for 10 sec.
 - ➔ A timer in the display runs up to **10**. Then **PA** is displayed and the WiFi symbol flashes.
 - ➔ You have reset your Comet WiFi to the factory settings. Perform the initial setup again, see  Section **5.3 Adding new device on Page 13**.



INFORMATION

For Comet WiFi devices with software version 4.9, only press the **reset button** briefly to reset your Comet WiFi to the factory settings.

9 TROUBLESHOOTING

Problems can also occur with your Comet WiFi. The following information will help you eliminate errors.

Problem	Cause	Remedy
The app does not show WiFi in the "My WiFi network" area.	<ul style="list-style-type: none"> Your router does not operate in the 2.4 GHz frequency range. The location detection (GPS) of your smartphone is deactivated or the app does not have access to it. 	<ul style="list-style-type: none"> Check whether your WiFi operates in the 2.4 GHz frequency range, as your Comet WiFi can only be integrated into a 2.4 GHz WiFi network. For more information, see the operating instructions for your router. Activate the location detection (GPS) of your smartphone. The app requires authorisation to access your location (GPS). Adjust this setting in your smartphone if necessary. For additional information, see the operating instructions for your smartphone.
C1	<ul style="list-style-type: none"> You have not entered the WiFi password correctly in the app. The WiFi signal strength is too weak. 	<ul style="list-style-type: none"> Delete your Comet WiFi from the app and add it again, see  Section 5.3 Adding new device on Page 13. Improve the WiFi signal strength of your home network by taking appropriate measures.
C2	<ul style="list-style-type: none"> The WiFi password has been changed. Interruption of the existing wireless connection. Set-up WiFi connection was temporarily interrupted (e.g. power failure, network cable) 	<ul style="list-style-type: none"> Your Comet WiFi must be reconnected to the WiFi network (by entering the new WiFi password). Improve the WiFi signal strength of your home network by taking appropriate measures. For example, check your power supply and network cable.
C3	WiFi connection without Internet access.	Check your Internet connection.
Batteries need to be changed frequently.	Check your WiFi signal strength.	Check your Internet connection.
E1-E3	Pressing any button clears the error indication in the display and the adaptation restarts.	
E1	No adaptation possible. Your Comet WiFi is not installed on the radiator.	Install your Comet WiFi correctly on the radiator.
E2	Valve stroke too short or battery power too low.	Open and close the valve plunger by hand several times or insert new batteries.
E3	No valve movement possible.	Press any button to acknowledge. Make sure that the valve plunger can move freely.
bt	The batteries are weak.	Change the batteries.

10 CLEANING AND STORAGE

Switch off your Comet WiFi and remove the batteries if you will not be using your Comet WiFi for a longer period of time. Store your Comet WiFi in a dry, dust-free place.



IMPORTANT!

Material damage possible!

Improper handling of the device can lead to damage.

- ➔ Do not immerse the device in water or other liquids.
- ➔ Do not use any brushes with metal or nylon bristles or sharp or metallic cleaning tools such as knives, hard spatulas and such. They can damage the surfaces.
- ➔ Clean the device with a soft, dry, lint-free cloth.
- ➔ Do not use cleaning agents or solvents.

11 APPENDIX

The following section contains information on technical data, customer service and other legal information.

11.1 TECHNICAL DATA

Designation	Comet WiFi
EAN	4260012711998
Article number	700200
Supply voltage	2× AA/LR6 batteries
Threaded connection	M30 × 1.5 mm
Method of operation	Type 1
Dimensions	62 × 68 × 83 mm
Weight	161 g (incl. batteries)
Protection class	IP 20
Degree of contamination	2
Measuring accuracy	±1 °C
WiFi frequency	2,412 MHz to approx. 2,472 MHz
Maximum transmission power	IEEE 802.11b: 18.29 dBm IEEE 802.11g: 19.30 dBm IEEE 802.11n: 18.41 dBm

Subject to technical changes at any time. Compatibility information provided without guarantee.

11.2 SUPPORT AND CONTACT

You can contact us for technical support.
We look forward to assisting you with your enquiry:

Phone: +49-(0)-6667-91847-0
E-mail: support@eurotronic.org
Customer service: **EUROtronic Technology GmbH**
Südweg 1
36396 Steinau-Ulmbach
Germany

11.3 DISPOSAL



INFORMATION

Please inform yourself about the options for returning old devices and used batteries free of charge at your retailer.



The adjacent symbol indicates that electrical and electronic apparatus no longer required must be disposed of separate from domestic waste in accordance with legal directives. Dispose of the device at a collection point provided by your municipal waste authorities.



Defective or spent batteries must be recycled according to Directive 2006/66/EC. Return batteries and / or the device via the recycling services offered.



Observe the identifications on the packaging when sorting the waste materials; the identifications are comprised of abbreviations (a) and numbers (b) and have the following significance: 1–7: plastics / 20–22: paper and cardboard / 80–98: composite materials.



Dispose of the packaging according to type. Dispose of cardboard and carton at waste paper collection points and foil at recyclables collection points. By recycling, material recovery or other forms of recycling, you are making an important contribution to protecting our environment.

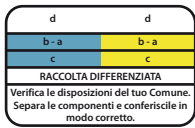

The logo only applies to Italy.

11.4 PERSONAL DATA

1. Delete all personal data from your user account of the **Eurotronic Smart Living 2.0** app before disposing of your Comet WiFi.

11.5 SIMPLIFIED DECLARATION OF CONFORMITY

CE EUROtronic Technology GmbH hereby declares that your Comet WiFi complies with all applicable Community provisions of the European Economic Area Directive 2014/53/EU. The entire text of the EU Declaration of Conformity is available at the following Internet address:
<https://eurotronic.org/service/downloads>

11.6 WARRANTY NOTICE

The warranty period is 24 months and begins on the day of purchase. Keep your receipt as proof of purchase. During the warranty period, defective energy-saving controllers can be sent to the service address with sufficient postage. To do this, contact our Customer Service before returning the item. You will then receive a new or repaired device in return free of charge. Repair or replacement of the device does not begin a new warranty period. Note that we only guarantee the functions of the device, not the functionality between the interaction of the device and the valve base.

The application-related technical data are only guaranteed together with the valves Heimeier, Junkers Landys+Gyr, MNG, Honeywell Braukmann thread dimension (M30x1.5), Oventrop (M30x1.5) Danfoss RA, RAV and RAVL. The unit combinations are specified on our website (www.eurotronic.org). When operating your Comet WiFi with third-party valves/adapters that are not listed, the functionality must be ensured by the user. EUROtronic does not provide warranty service in these cases.

After the warranty period has expired, you also have the option of sending the defective unit to the address provided, with sufficient postage, for the purpose of repair. Repairs required after the expiration of the warranty period are subject to a charge. Your statutory rights are not limited by this warranty.

11.7 MANUFACTURER

EUROtronic Technology GmbH
Südweg 1, 36396 Steinau-Ulmbach
Germany

+49 (0) 6667 91847-0
support@eurotronic.org
www.eurotronic.org



EUROtronic Technology GmbH
Südweg 1 | 36396 Steinau-Ulmbach | Germany
www.eurotronic.org