

Energy-Saving Controller Comet Zero ZigBee -Starter Set-

OPERATING INSTRUCTIONS



LEGAL NOTICE

Operating Instructions Energy-Saving Controller **Comet Zero** ZigBee - Starter Set -

Manufacturer

EUROtronic Technology GmbH
Südweg 1
36396 Steinau-Ulmbach
Germany
www.eurotronic.org

Status 2024.04
Version 1.0 / EN

Publisher

Ingenieurbüro FORMAT GmbH
Ebertstraße 80
26382 Wilhelmshaven
Germany
www.format-docu.de

Legal Information

All brand names and trademarks mentioned in this document and protected by third-party rights, are subject without restriction to the provisions of the applicable trademark law and the ownership rights of the respective registered owners. Comply with all local and regional laws and regulations as well as the safety regulations referred to in this document.

Copyright Notice

The contents of this document are protected by copyright.
The disclosure, transfer and any other distribution of the contents of this document to third parties, the making of copies, transcripts and other reproductions as well as utilisation and any other use are prohibited - even in part - without the prior, express and written consent of the author.

© 2024 All rights reserved.

CONTENTS



This operating manual provides assistance for starting up and using the Comet Zero ZigBee and ET Home Link gateway. Read this operating manual carefully and thoroughly before you start to use the Comet Zero ZigBee and ET Home Link gateway. Keep this operating manual in a safe place and hand over all documents when passing the equipment on to third parties.

1	Safety Information.....	5
1.1	Depiction of Warnings	5
1.2	Warnings.....	6
2	Scope of Delivery	9
3	Overview.....	10
3.1	Proper Use.....	10
4	Controls and Display Elements	11
4.1	Operating Elements	12
4.2	Comet Zero ZigBee Display Elements.....	13
4.3	ET Home Link Gateway Display Elements.....	14
5	Putting into Operation.....	16
5.1	Installing the ET HomeLink App.....	17
5.2	Connect the Gateway with the App	18
5.2.1	Adding the Gateway	18
5.2.2	Selecting Network	19
5.2.3	Connecting the Gateway to the Power Supply	20
5.2.4	Configuring your Gateway	21
5.2.5	Concluding Configuration of the Gateway	27
5.3	Connecting the Comet Zero ZigBee	28
5.3.1	Adding the Comet Zero ZigBee	28
5.3.2	Inserting Batteries	30
5.3.3	Configuring the Comet Zero ZigBee	31
5.3.4	Selecting the Gateway	32
5.3.5	Installing on Rddiator	34
5.3.6	Adaptation.....	36
5.3.7	Naming and Assigning Comet Zero ZigBee	37
6	Operation and functions.....	39
6.1	Operating the ET Home Link Gateway.....	41
6.2	Operating the Comet Zero ZigBee	43
6.2.1	Setting Temperature in a Room	44
6.2.2	Device Settings.....	46
6.2.3	Heating Profile	47
6.2.4	Absence Plan.....	51

6.3	Further Functions of the Comet Zero ZigBee	55
6.4	Disconnecting the ZigBee Connection.....	56
6.5	Resetting the Default Factory Settings	58
7	Disassembly.....	59
8	Troubleshooting.....	60
9	Cleaning and Storage.....	62
10	Appendix.....	63
10.1	Technical Data	63
10.2	Adapter Overview	65
10.3	Support and Contact.....	67
10.4	Disposal.....	67
10.5	Personal Data.....	68
10.6	Simplified Declaration of Conformity	68
10.7	Warranty Notice.....	68
10.8	Manufacturer	69

1 SAFETY INFORMATION

In addition to the safety information in these operating instructions, all other available sources must also be observed.

The areas of use defined in the written explanations of the **intended use** must be observed.

1.1 DEPICTION OF WARNINGS

The warnings used in these operating instructions have the following meaning:



WARNING!

There is a risk of serious injury or even fatal injury if the warning sign containing this signal word is ignored.

→ Probability of occurrence: possible



CAUTION!

Moderate to minor personal injury may occur if warnings with this signal word are disregarded.

→ Probability of occurrence: possible



IMPORTANT!

Material damage can occur if warnings with this signal word are disregarded.

→ Probability of occurrence: possible



INFORMATION

Contains additional information.

1.2 WARNINGS

When operating the Comet Zero ZigBee and its components, risks may arise that can be avoided by observing the following warnings.



WARNING!

Danger of electric shock!

Improper handling of the product can lead to injuries.

- Never open or repair your gateway.
- Never touch the bare contacts of your gateway with metal objects.
- Place the gateway near an easily accessible power socket.
- Never plug or unplug the power supply unit of your gateway with wet hands.



WARNING!

Risk of fatal injury and accidents to infants, children and pets!

Risk of choking and suffocation through parts of the Comet Zero ZigBee, the ET Home Link gateway, batteries or packaging materials.

- Never leave children and pets unattended with the Comet Zero ZigBee, ET Home Link gateway or packaging material. Children underestimate the risks involved. Keep children away from the Comet Zero ZigBee, ET Home Link gateway and packaging material.
- Keep batteries out of reach of children. Should a battery be swallowed, seek medical attention immediately.



CAUTION!

Burns caused by hot radiator valve!

Touching can cause burns to the hand.

- Allow the radiator to cool down before installing, removing or troubleshooting your device!
- Wear protective gloves



CAUTION!

Risk of injury through exploding or leaking batteries!

Improper handling of batteries can lead to an explosion.

- Only use batteries of the type specified.
- Never attempt to charge non-rechargeable batteries.
- Switch the device off and remove the batteries if the device will not be used for a longer period.
- Do not heat batteries and do not throw them into open flames or water.
- Do not place batteries in direct sunlight.
- Protect batteries from excessive heat.
- Do not short-circuit batteries.
- Never dismantle batteries.
- Do not use new and used batteries together.
- When inserting the batteries, observe the correct polarity (+/-).
- Before inserting the batteries, clean the batteries and the contacts in the device.
- Avoid contact of battery acid with skin, eyes and mucous membranes.
- In case of contact with battery acid, immediately rinse the affected areas with clean water and consult a doctor.
- Remove dead batteries from the device.
- Remove batteries from the device before disposing of the device.
- Improper handling of batteries can have adverse effects on your health and the environment. Batteries can contain toxic and environmentally harmful heavy metals (Cd = cadmium, Hg = mercury, Pb = lead). Therefore, separate disposal and recycling of used batteries is essential for environmental and health reasons.



CAUTION!

Risk of injury due to malfunction!

Malfunctions can lead to injuries.

- Never carry out any repair work on the Comet Zero ZigBee or ET Home Link gateway yourself.
- Do not open the Comet Zero ZigBee or ET Home Link gateway.
- Do not short circuit the connection terminals of the Comet Zero ZigBee and ET Home Link gateway.
- Never complete any modifications or conversion work on the Comet Zero ZigBee or ET Home Link gateway.
- Do not operate the Comet Zero ZigBee or ET Home Link gateway if there are visible signs of damage.
- In the event of an error, contact Customer Service.



IMPORTANT!

Material damage and malfunction possible!

Your Comet Zero ZigBee and ET Home Link gateway can be used by children aged from 8 years and above and persons with restricted physical, sensory or mental capabilities or lack of experience and knowledge if they are supervised or have been instructed on the safe use of the equipment and understand the hazards involved.

- ➔ Children must not play with the Comet Zero ZigBee and ET Home Link gateway.
- ➔ Cleaning and user maintenance must not be carried out by children without supervision.



IMPORTANT!

Material damage and malfunction possible!

Environmental influences could affect the functionality of the Comet Zero ZigBee and ET Home Link gateway.

- ➔ Never expose the Comet Zero ZigBee and ET Home Link gateway to direct sunlight.
- ➔ Only use the Comet Zero ZigBee and ET Home Link gateway in a dry, dust-free environment.



IMPORTANT!

Material damage and malfunction possible!

Damaged components and/or malfunctions prevent the Comet Zero ZigBee and ET Home Link gateway from working properly.

- ➔ If material damage and/or malfunctions occur, contact the Customer Service of Eurotronic Technology GmbH.

2 SCOPE OF DELIVERY

Check the scope of delivery for completeness as well as for visual and technical defects before putting your Comet Zero ZigBee -Starter Set- into operation.

- 2× Comet Zero ZigBee energy-saving controllers
- 1× ET Home Link gateway
- 1× power cable for gateway
- 1× Quick Guide
- 2× adapter sets (Danfoss RA / RAV / RAVL)
- 2× screws and 2× nuts for adapter
- 4× AA/LR6 batteries

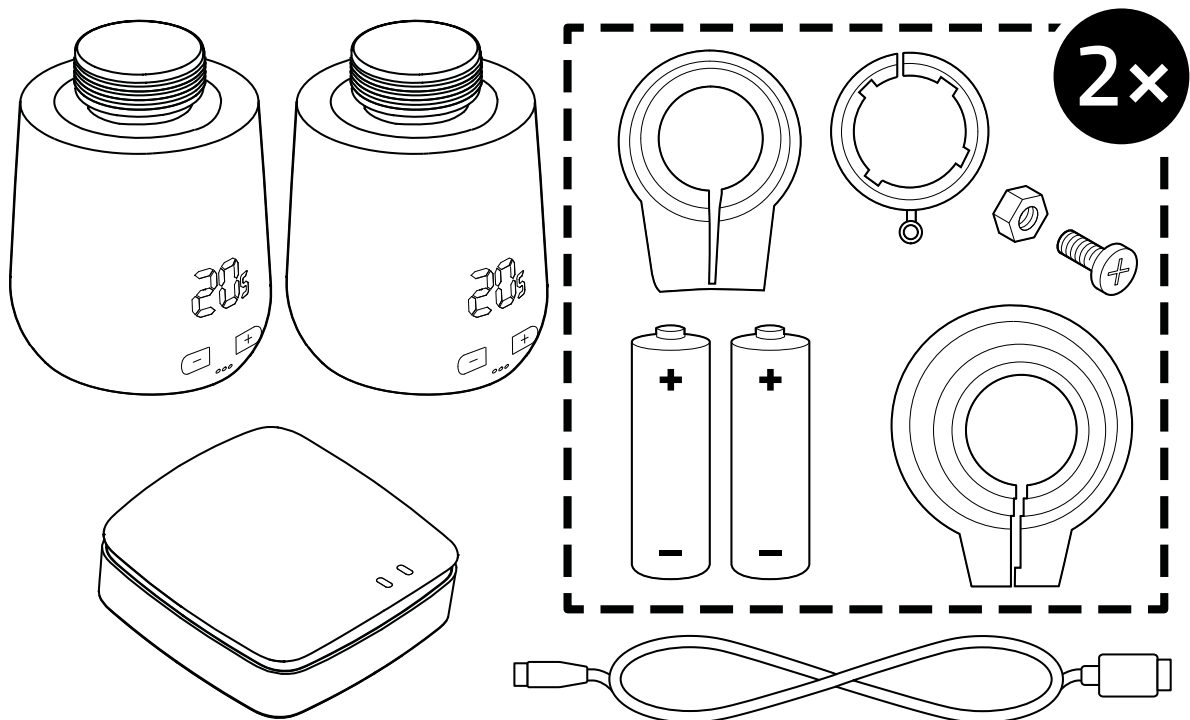

IMPORTANT!

Material damage and malfunction possible!

Damaged components and/or malfunctions prevent the Comet Zero ZigBee and Gateway ET Home Link from working properly.

- ➔ If material damage and/or malfunctions occur, contact the Customer Service of Eurotronic Technology GmbH.

*When using the RAV adapter, the RAV pin is required to extend the valve plunger.

3 OVERVIEW

Thank you for choosing a product from EUROtronic Technology GmbH. Your Comet Zero ZigBee is an energy-saving controller for radiators equipped with the ZigBee wireless standard providing modern, simple operation. It is connected to your ET Home Link gateway and automatically regulates your room temperature according to your specifications and is configurable, either directly on the thermostat or conveniently with a smartphone via the ET HomeLink app. Your Comet Zero ZigBee helps you to effectively reduce your heating costs.

Development and production are 100% "Made in Germany"; which guarantees premium quality and technology. This operating manual will help you to get your ET Home Link gateway and Comet Zero ZigBee up and running quickly and easily.



INFORMATION

The drawings in these instructions are for the purpose of illustration and are not necessarily to scale. Product designations and pictograms on screenshots may differ from the actual product. EUROtronic Technology GmbH reserves the right to change the design or dimensions without prior notice.

3.1 INTENDED USE

Your Comet Zero ZigBee is used to regulate a heater radiator valve indoors. It is forbidden to complete any unauthorised modifications, conversions and repairs. Do not use rechargeable batteries

The ET Home Link gateway serves as a central interface between the ET HomeLink app and the Comet Zero ZigBee connected. The ET Home Link gateway uses the ZigBee wireless interfaces and Wi-Fi to communicate with other devices.



INFORMATION

The ET Home Link gateway can be used to control the Comet Zero ZigBee. Other ZigBee devices are not supported and will be rejected by the ET Home Link gateway.

Only use the ET Home Link gateway and Comet Zero ZigBee indoors.

Any use other than that described in these operating instructions is not in accordance with the intended use and will result in the warranty being voided and exclusion of liability. It is forbidden to complete any unauthorised modifications, conversions and maintenance. The Comet Zero ZigBee and ET Home Link gateway are exclusively intended for private use.

4 CONTROLS AND DISPLAY ELEMENTS

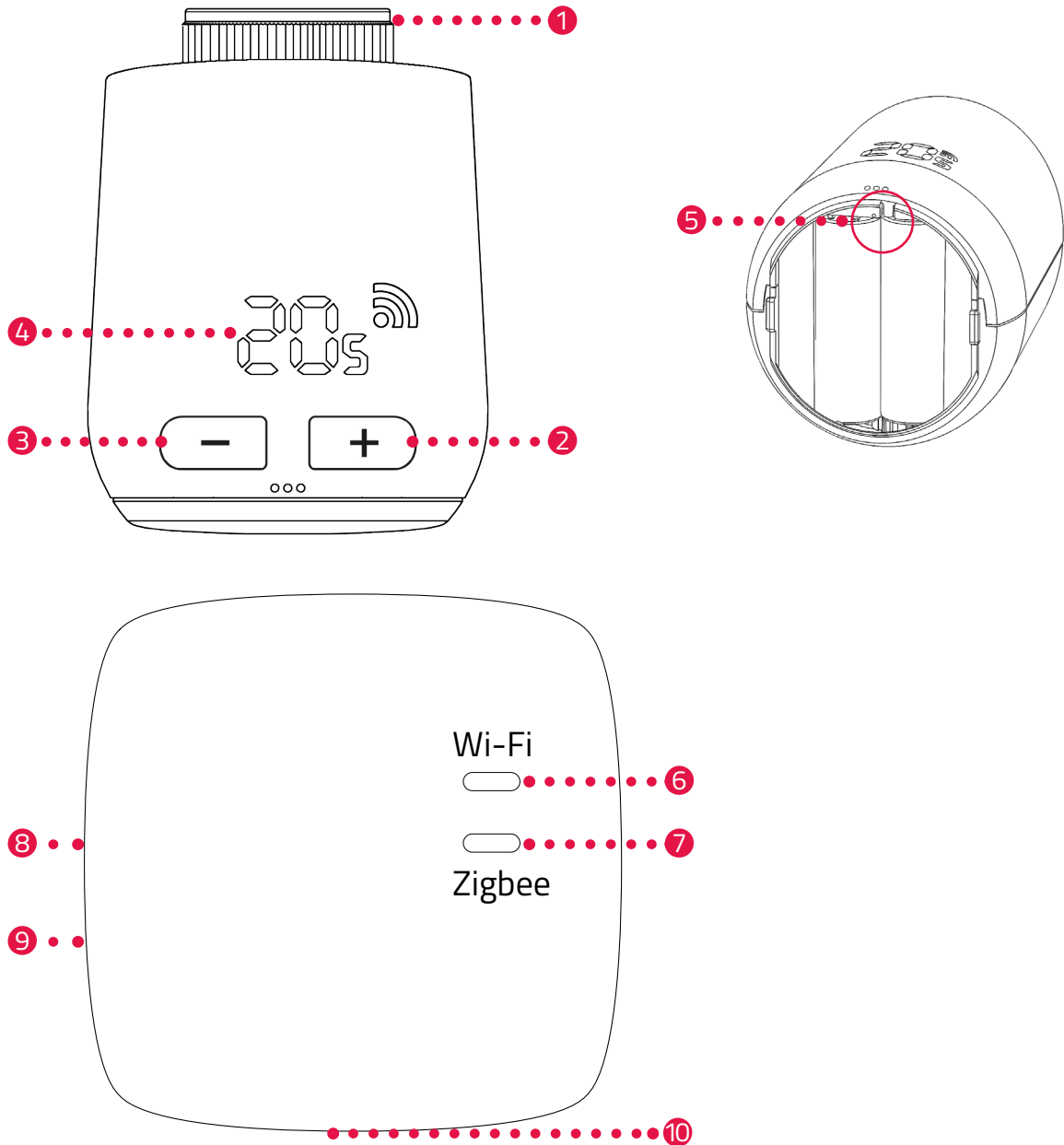

The following section describes the operating and display elements on the Comet Zero ZigBee and ET Home Link gateway.



- | | |
|-----------------------------------|-----------------------------------|
| ① Union nut | ⑥ Wi-Fi LED |
| ② + button (increase temperature) | ⑦ ZigBee LED |
| ③ - button (decrease temperature) | ⑧ Reset button (on the rear side) |
| ④ Display | ⑨ NFC contact surface |
| ⑤ Reset button | ⑩ Micro USB port |

4.1 OPERATING ELEMENTS

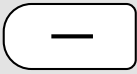
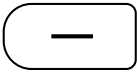
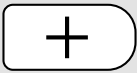
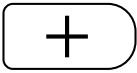





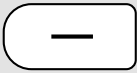

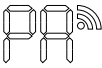
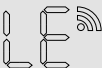
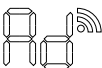

COMET ZERO ZIGBEE

Button	Action	Function
	Press briefly	Lower the temperature by 0.5 °C.
	Press and keep pressed	Lower the temperature by 0.5 °C, then lower the temperature by 0.5 °C every 0.5 sec. until the lowest temperature is reached or the button is released.
	Press briefly	Raise the temperature by 0.5 °C.
	Press and keep pressed	Raise the temperature by 0.5 °C, then raise the temperature by 0.5 °C every 0.5 sec. until the highest temperature is reached or the button is released.
Reset button	Press and keep pressed for 5 sec.	The Comet Zero ZigBee reacts to the interruption of input from the gateways (exclusion).
Reset button	Press and keep pressed for 10 sec.	The Comet Zero ZigBee is reset to its default factory settings.
	Press both buttons for 3 sec.	Activate/Deactivate the key lock function.
	Ad appears in the display, press both buttons for 3 sec.	Start adaptation.

ET HOME LINK GATEWAY

Button	Action	Function
	Press button and keep pressed for 5 sec.	ET Home Link gateway is reset.

4.2 COMET ZERO ZIGBEE DISPLAY ELEMENTS

Symbol	Designation	Function
	Radio symbol	Indicates a communication connection or a pairing process. If the symbol is not displayed, there is no radio communication.
	Pairing mode (inclusion)	Indicates pairing mode is active in order to connect the device with a gateway.
	Disconnecting mode (exclusion)	Indicates disconnecting mode is active in order to disconnect the device from a gateway.
	Adaptation	Indicates that adaptation to the radiator valve can be started.
	Animation	Indicates that adaptation is active, the process can take a little while.
	Animation	Indicates that the key lock function has been activated or deactivated.
	Low battery charge	Indicates that the battery charge status is under 25%.
	Error message	Indicates that disconnection of the device from the gateway (exclusion) has failed.
	Error message	Indicates that pairing of the device to the gateway (inclusion) has failed.
	Error message	Indicates that the error E1 has occurred, see  in Section 8 Troubleshooting on Page 60.
	Error message	Indicates that the error E3 has occurred, see  in Section 8 Troubleshooting on Page 60.

4.3 ET HOME LINK GATEWAY DISPLAY ELEMENTS

WI-FI LED

Status	Colour	Function
Configuration mode	Flashes green/yellow	Configuration mode is active. The gateway can be added to the app.
Establishing a connection	Flashes green/yellow 2× in succession	The gateway is connecting to the server.
Operating status	Lights up green/yellow	The gateway is in normal operating status.
Data transfer	Flashes green/yellow once, briefly	The gateway is sending or receiving data.
Update	Lights up orange	The gateway or a Comet Zero ZigBee connected is being updated.
Reset	Flashes red 2 ×	The gateway is being reset to its default factory settings.
Error status C1	Flashes red 1× every 2 seconds	The Wi-Fi password has been entered incorrectly in the app. The gateway cannot connect to the Wi-Fi network.
Error status C2	Flashes red 2× every 2 seconds	The Wi-Fi connection is interrupted.
Error status C3	Flashes red 3× every 2 seconds	The Wi-Fi connection exists but there is no connection to the server.

ZIGBEE LED

Status	Colour	Function
Search	Flashes yellow/green, briefly, every 2 seconds	The gateway searches for ZigBee devices which are available.
Establishing a connection	Flashes green/yellow quickly	The ZigBee network is being established.
Normal operation	Lights up yellow/green	The gateway is in normal operating status.
Data transfer	Flashes yellow/green 1x, briefly	The gateway is sending or receiving data.
Update	Lights up orange	The gateway or a Comet Zero ZigBee connected is being updated.
Reset	Flashes red 2 x	The gateway is being reset to its default factory settings.
Error status	Lights up red	Error in the ZigBee network.

5 PUTTING INTO OPERATION

The following preparations must be completed prior to assembly:

- Install the **ET HomeLink** app on your smartphone.
- Connect your ET Home Link gateway to the app.
- Connect your Comet Zero ZigBee to your gateway.

The connection process of ZigBee devices is referred to as "inclusion". The disconnection process is referred to as "exclusion". Both processes must be initiated from your ET Home Link gateway.

Behaviour in the ZigBee Network

The Comet Zero ZigBee can be added to a ZigBee network in order to communicate with other ZigBee certified devices and/or applications from different manufacturers.

All the network nodes which are not battery powered, regardless of their manufacturer, function as repeaters and improve the reliability of the wireless ZigBee network.

Network Security

The Comet Zero ZigBee can communicate encrypted with other ZigBee devices when they also support encrypted communication. If this is not the case, the Comet Zero ZigBee communicates unencrypted.

The following sections describe the procedure using the **ET HomeLink** app for the Android operating system. The procedure may differ for the iOS operating system.



INFORMATION

The following screenshots show the app at the time of publication of this operating manual. Newer versions of the app may differ in appearance and content.

Please note that parts illustrated in the screenshots could deviate in appearance from your products.

5.1 INSTALLING THE ET HOMELINK APP

1. Download the **ET HomeLink** app from Google Play (Android) or the App Store (iOS).
2. Install the app on your smartphone.

System requirements:

Android from version 6.0

iOS from version 13

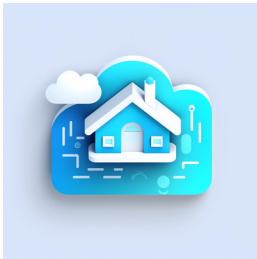

INFORMATION

During the initial setup of the app, requests are made as to whether the app is granted authorisation to access functions of your smartphone. Allow access to use the full range of functions of your Comet Zero ZigBee.

3. Open the app on your smartphone and follow the instructions.
4. Create a new user account to use the app. Please note that existing user accounts from Eurotronic Smart Living 2.0 are not compatible.
→ The main view, **My Home**, appears on the screen.

5.2 CONNECT THE GATEWAY WITH THE APP

The following sections describe how to add your ET Home Link gateway to the app.

5.2.1 ADDING THE GATEWAY

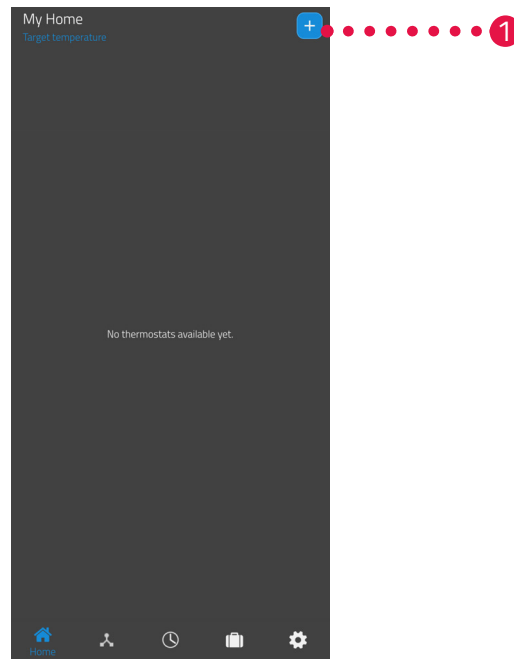

1. Tap on the  button to add a new device.

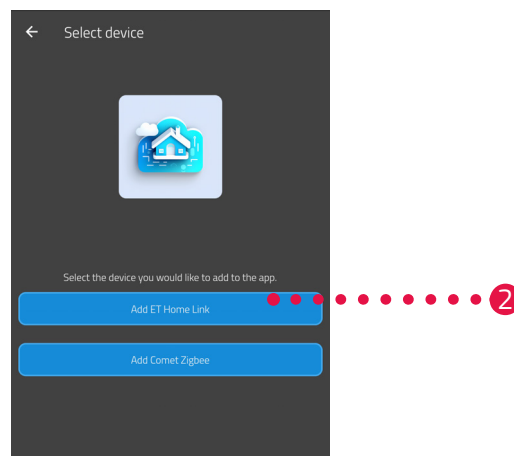

2. Tap on the **Add ET Home Link** button.
3. Then follow the instructions displayed by the setup assistant for starting up the ET Home Link gateway for the first time.

5.2.2 SELECTING NETWORK

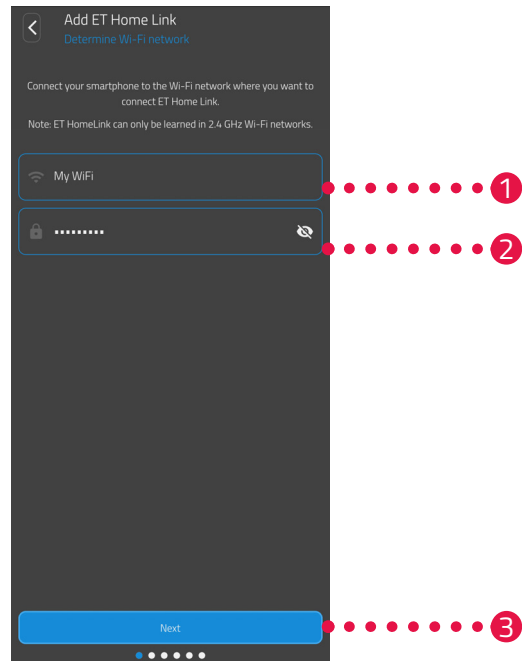

1. The WiFi network to which your smartphone is connected is automatically displayed. If necessary, you can integrate the ET Home Link gateway in another Wi-Fi network. To do this, close the app and connect your smartphone to the required Wi-Fi network.



INFORMATION

For your WiFi to be displayed in the My WiFi Network field, the following requirements must be met:

- Your WiFi must transmit in the 2.4 GHz frequency range. If your router only supports the 5 GHz frequency range, operation of your Comet Zero ZigBee is not possible. For more information, see the operating instructions for your router.
- The location detection (GPS) of your smartphone must be activated.
- The **ET HomeLink** app requires authorisation to access your location (GPS). Adjust this setting in your smartphone, if necessary. For more information, see the operating instructions for your smartphone.

2. Enter your Wi-Fi password in the input field. Make sure you spell your password correctly. The app will not check your WiFi's password. If the password is entered incorrectly, the setup process still continues but a connection to your ET Home Link gateway cannot be established.
3. Tap the **Next** button.

5.2.3 CONNECTING THE GATEWAY TO THE POWER SUPPLY

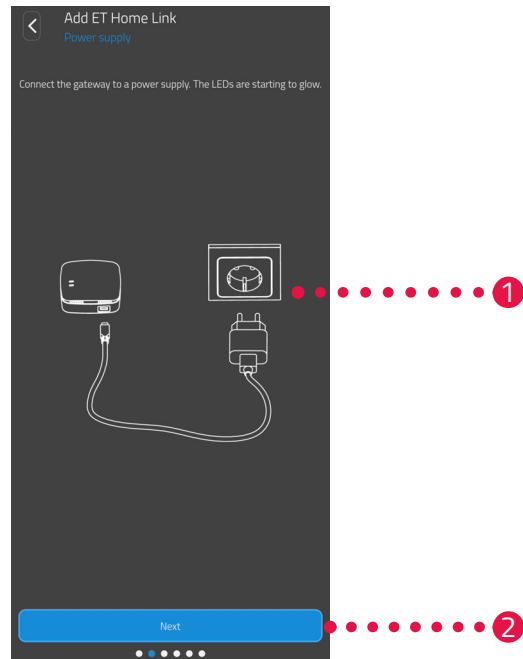

1. Connect the ET Home Link gateway to a suitable power socket using the micro-USB cable and an appropriate USB power adapter, as illustrated.



INFORMATION

No USB power adapter is contained in the package supplied. Use an appropriate USB power adapter with the following technical data:
- Output: 5 V DC, 1 A

2. Tap the **Next** button.

5.2.4 CONFIGURING YOUR GATEWAY

The ET Home Link gateway is now automatically in Configuration mode. When Configuration mode is activated, the ZigBee LED lights up green/yellow continuously and the Wi-Fi LED flashes green/yellow.



INFORMATION

If the LEDs indicate a different status, reset the ET Home Link gateway to its default factory settings (see  Section **6.5 Resetting the Default Factory Settings on Page 58**) and repeat the process.

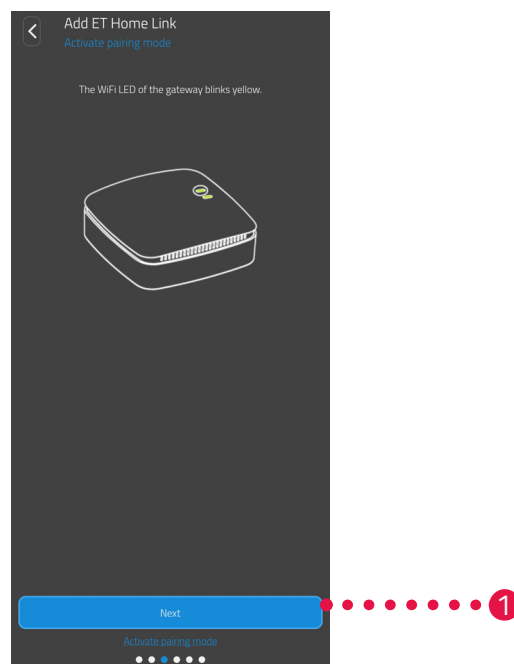

1. Tap the **Next** button.

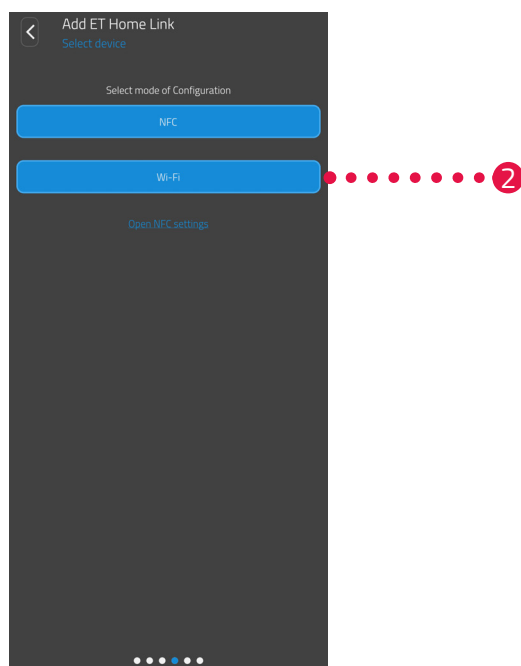

2. Tap on the Configuration mode required:
NFC, continue with Section **Configuration with NFC on Page 23**
WiFi, continue with Section **Configuration using Wi-Fi on Page 25**

CONFIGURATION WITH NFC

After selecting the **NFC** option, follow the subsequent instructions. The NFC function ("Near Field Communication") enables compatible devices nearby to exchange data with each other by implementing wireless communication.



INFORMATION

A condition for using the NFC configuration mode is that your smartphone supports the NFC function and that the function has been activated on the smartphone. For more information, see the operating instructions for your smartphone.

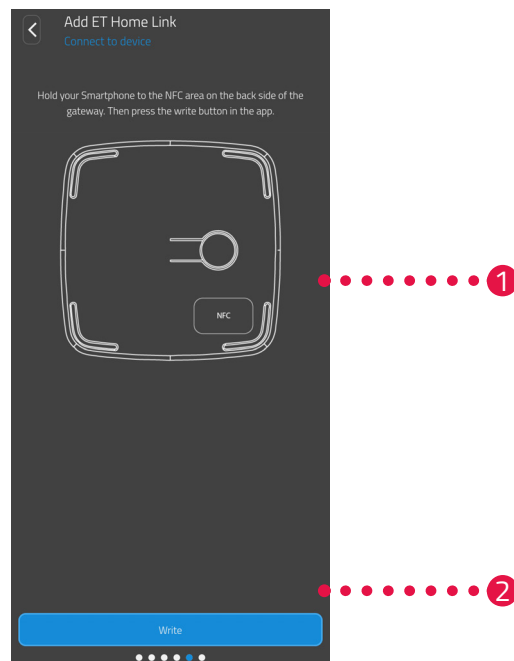

1. Lay the NFC contact surface of your smartphones (rear side) as illustrated on the NFC contact surface of the ET Home Link gateway.
2. Tap on the **Write** button.
→ The configuration data is transferred from the smartphone to your ET Home Link gateway.

Comet Zero ZigBee -Starter Set- Putting into Operation

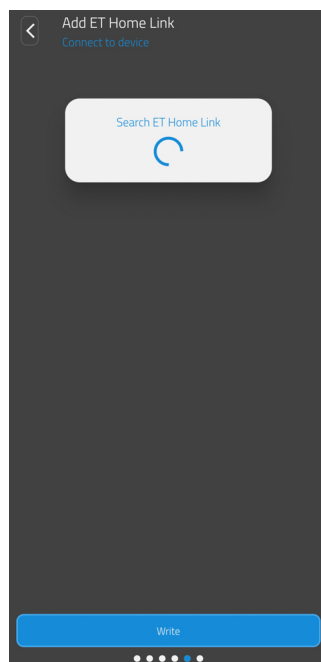

3. Wait until the configuration process has been completed.



4. When the configuration process has been completed, tap on the **Next** button.

CONFIGURATION USING WI-FI

After selecting the **Wi-Fi** option, follow the subsequent instructions.

The process differs according to the operating system (Android, iOS) used on your smartphone. The following instructions describe the procedure for Android.

If you use the iOS operating system, the Wi-Fi configuration (instruction steps 1 - 4) are automatic.

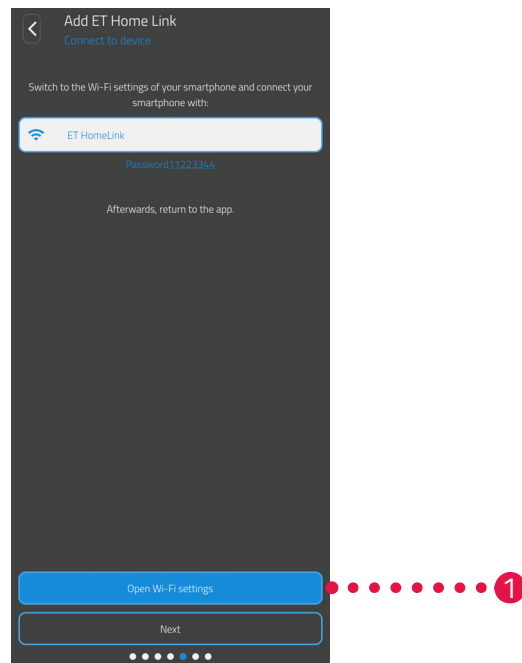

1. Tap on the **Open Wi-Fi settings** button.
→ The Wi-Fi settings on your smartphone are displayed.
2. Tap on the **ET Home Link** option.
3. If necessary, enter the standard password **ET Home Link** Wi-Fi link: **11223344**.
4. Switch back to the **ET HomeLink** app.

Comet Zero ZigBee -Starter Set- Putting into Operation

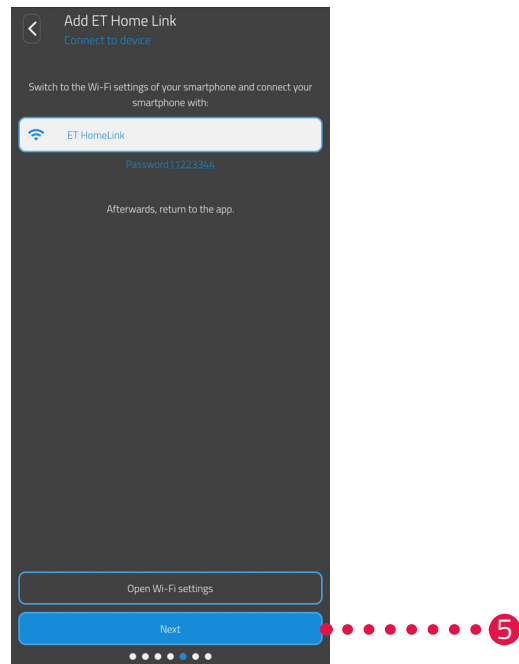

5. Tap the **Next** button.

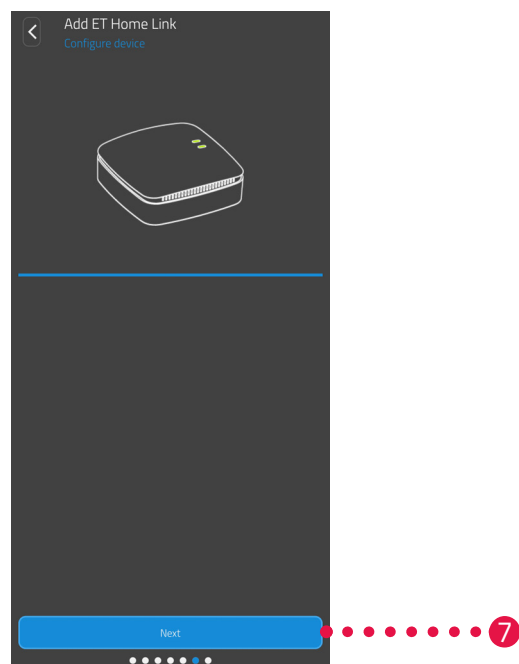

- 6. Wait until the configuration process has been completed.
- 7. When the configuration process has been completed, tap on the **Next** button.

5.2.5 CONCLUDING CONFIGURATION OF THE GATEWAY

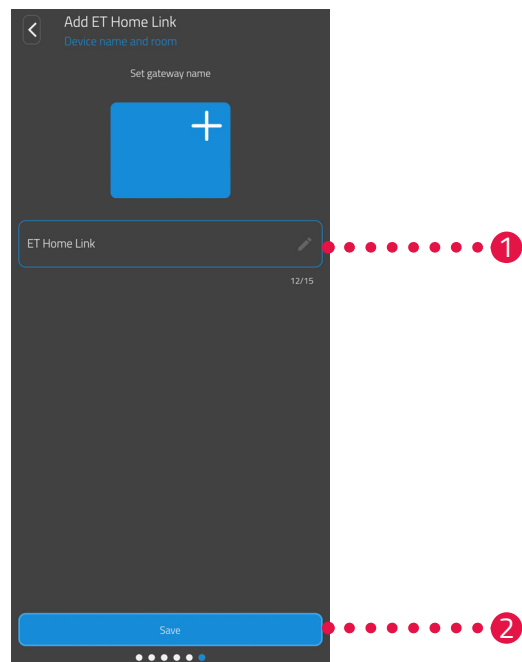

1. Assign an unambiguous name for the ET Home Link gateway. The name appears in the app.
2. Tap the **Save** button.
 - ➔ You have completed configuration of the ET Home Link gateway successfully. During the next step, the Comet Zero ZigBee will be connected to the ET Home Link gateway.

5.3 CONNECTING THE COMET ZERO ZIGBEE

The following sections describe how to add your Comet Zero ZigBee to the gateway and the app.

5.3.1 ADDING THE COMET ZERO ZIGBEE

Ensure that the following conditions are fulfilled:

- Your ET Home Link gateway has been configured.

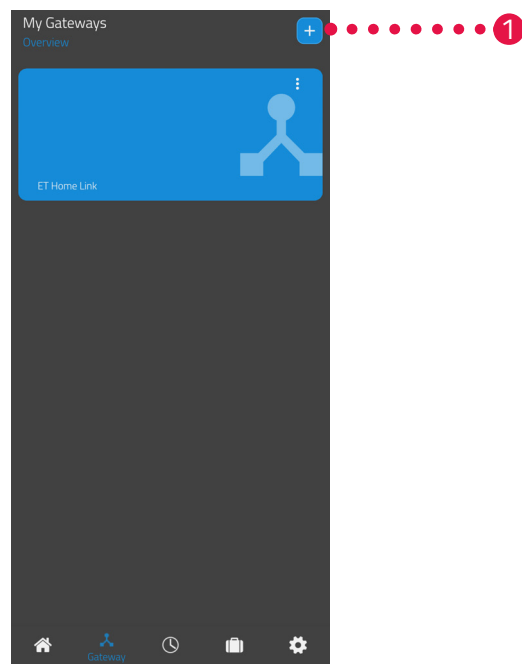

1. Tap the + button to add a new device.

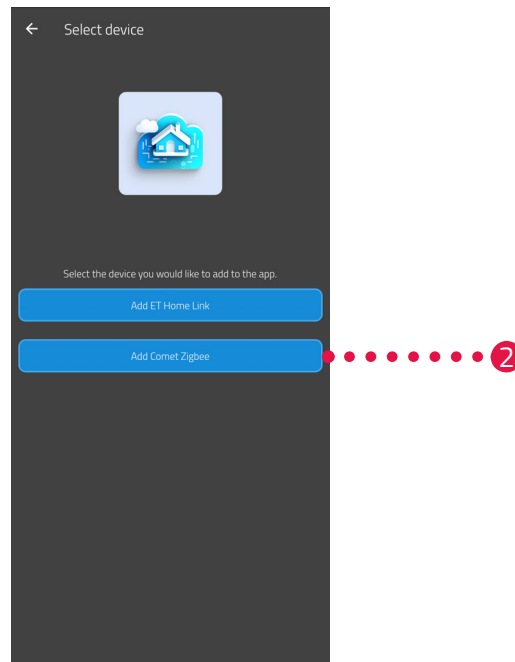

2. Tap on the **Add Comet ZigBee** button.
3. Then follow the steps displayed in the setup wizard to set up your Comet Zero ZigBee for initial operation.



INFORMATION

If any errors occur (e.g. **C1**), press the **- button** or **+ button** to confirm the error message and repeat the process.

4. If so required, you can use the method described above to add more devices.

5.3.2 INSERTING BATTERIES

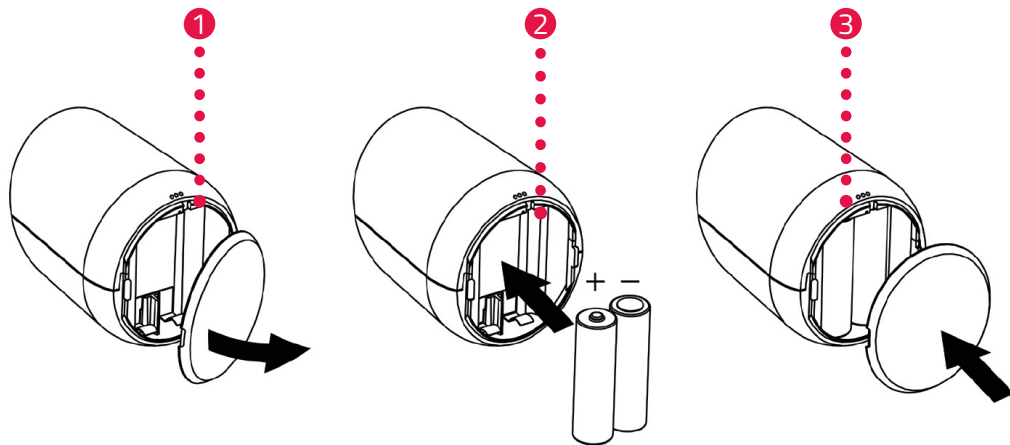

1. Open the battery compartment cover.
2. Insert the batteries provided as shown.
Pay attention to the correct polarity and do not use rechargeable batteries!
3. Close the battery compartment cover.
 - The battery compartment cover audibly clicks into place.
 - PA appears in the display.



INFORMATION

If PA does not appear in the display, reset the Comet Zero ZigBee to its default factory settings (see [Section 6.5 Resetting the Default Factory Settings on Page 58](#)) and repeat the process.

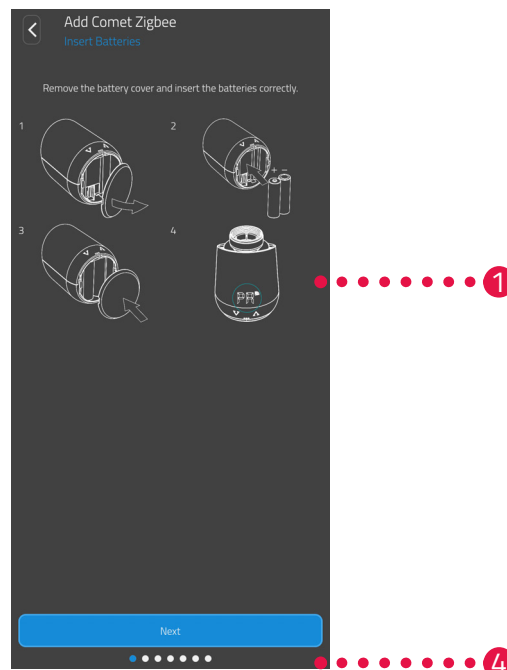

4. Tap the **Next** button.

5.3.3 CONFIGURING THE COMET ZERO ZIGBEE

PA appears in the display of the Comet Zero ZigBee and the radio symbol flashes. A countdown indicator appears in the display.

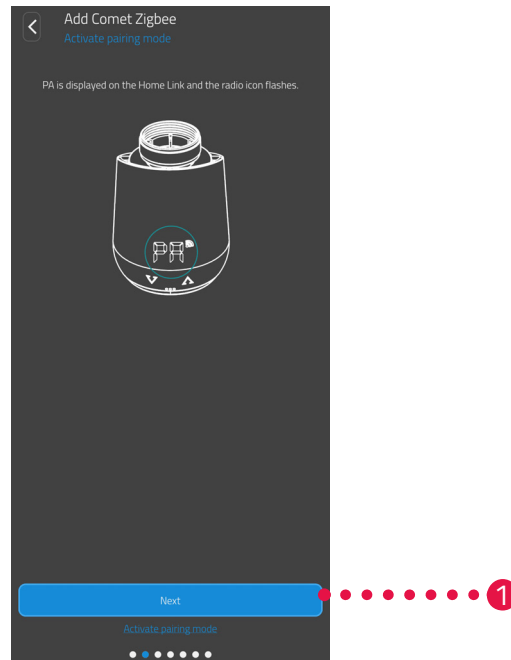

1. Tap the **Next** button.



INFORMATION

If any errors occur (e.g. **C1**), press the **- button** or **+ button** to confirm the error message and repeat the process.

5.3.4 SELECTING THE GATEWAY

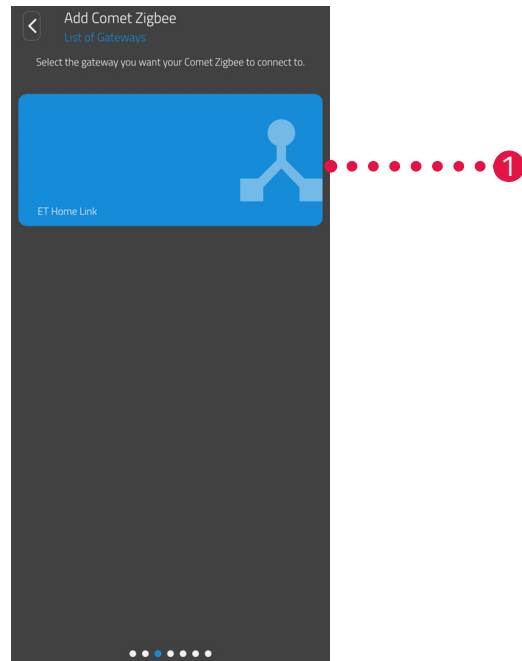

1. Tap on the required gateway (e.g. ET Home Link).

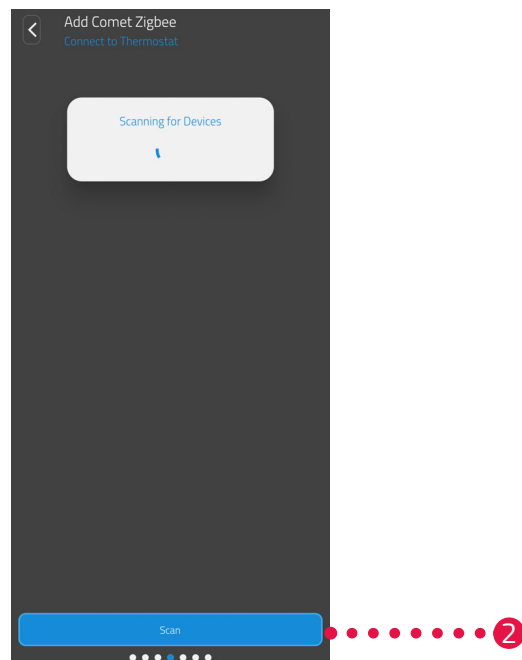



2. Tap on the **Scan** button to add the Comet Zero ZigBee to the gateway selected.
 - ➔ A corresponding message appears when the process is successful.
 - ➔ The Comet Zero ZigBee runs to its installation position and provides a corresponding animation in the display.

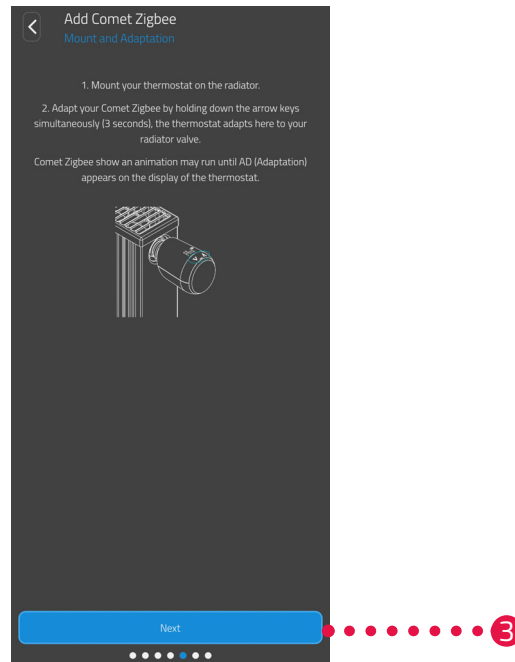

INFORMATION

If any errors occur (e.g. **C1**), press the **- button** or **+ button** to confirm the error message and repeat the process.



3. When **Ad** appears in the display, install the Comet Zero ZigBee on the radiator (see  Section 5.3.5 **Installing on radiator on Page 34**) and tap on the **Next**. button

5.3.5 INSTALLING ON RADIATOR

When **Ad** appears in the display, install the Comet Zero ZigBee on the radiator required.

The Comet Zero ZigBee can be installed on all known valve bodies (see adapter list at www.eurotronic.org/service/faq).



CAUTION!:

Burns caused by hot radiator valve!

Touching can cause burns to the hand.

- ➔ Do not touch hot radiator valves!
- ➔ Allow the radiator to cool down before installing, removing or servicing your Comet Zero ZigBee!

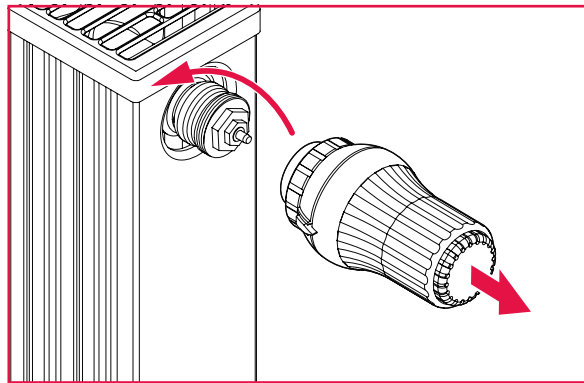

1. Open the current controller head completely.
2. Loosen the fastening and pull the controller head off the radiator.

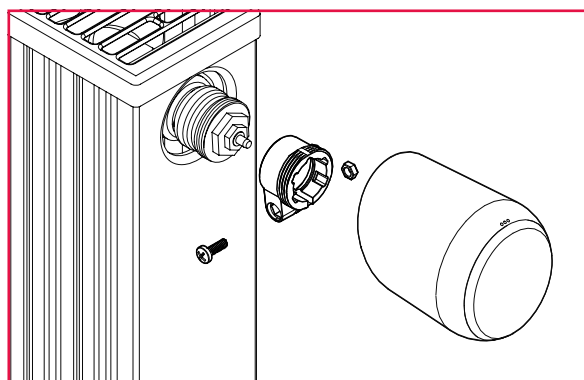

3. Optional: Select a suitable adapter from the scope of delivery. For additional information on the adapters, please see the  Section **10.2 Adapter overview on Page 65**.

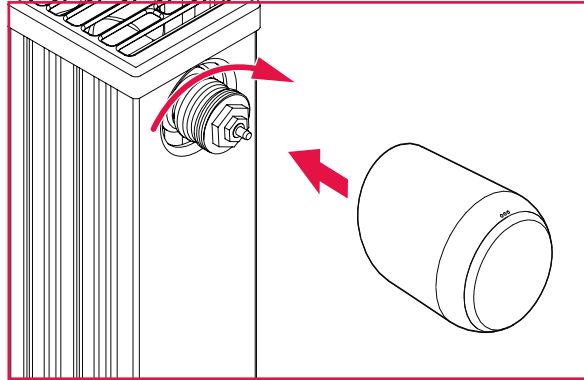

4. Position your Comet Zero ZigBee on the radiator and turn the union nut clockwise.
 - ➔ You have successfully installed your Comet Zero ZigBee.
 - ➔ Following installation, start the adaptation, see  Section **5.3.6 Adaptation on Page 36**.



INFORMATION

When installing/removing your Comet Zero ZigBee at a later date, please note that it must be in the adaptation mode. To do this, open the battery compartment cover and remove the batteries. Replace the batteries after approx. 10 seconds and close the battery compartment cover. Your Comet Zero ZigBee restarts and is in the adaptation mode. **Ad** appears in the display.

5.3.6 ADAPTATION

After successful installation, your Comet Zero ZigBee can begin with the adaptation. The condition is that **Ad** is shown in the display of your Comet Zero ZigBee.

1. To start the adaptation, simultaneously press and hold the **+ button** and **- button** on the Comet Zero ZigBee for approx. 3 seconds.
 - An animation appears in the display during the course of the process.
 - During the adaptation process, the Comet Zero ZigBee adapts to the stroke of the lower valve section. For this purpose, the valve is opened and closed several times to detect the respective end points. The process may take a moment. After successful adaptation, your Comet Zero ZigBee switches to normal operation.
 - The set temperature (21 °C) and radio symbol are displayed.

If a problem occurs with the Comet Zero ZigBee a new adaptation is necessary.



INFORMATION

If any errors occur, press the **- button** or **+ button** to confirm the error message and repeat the process.



INFORMATION

The Comet Zero ZigBee must be adapted again each time the battery has been changed.

Complete the following working steps:

1. Open the battery compartment cover.
2. Remove the batteries and wait for 10 seconds.
3. Then reinsert the batteries.
Pay attention to the correct polarity and do not use rechargeable batteries!
4. Close the battery compartment cover.
 - The Comet Zero ZigBee restarts and enters adaptation mode.
 - **Ad** appears in the display.
5. To start the adaptation, simultaneously press and hold the **+ button** and **- button** on the Comet Zero ZigBee for approx. 3 seconds.
 - An animation appears in the display during the course of the process.

5.3.7 NAMING AND ASSIGNING COMET ZERO ZIGBEE

After successful installation and adaptation, you can assign the Comet Zero ZigBee a name in the app and assign the Comet Zero ZigBee to a room.

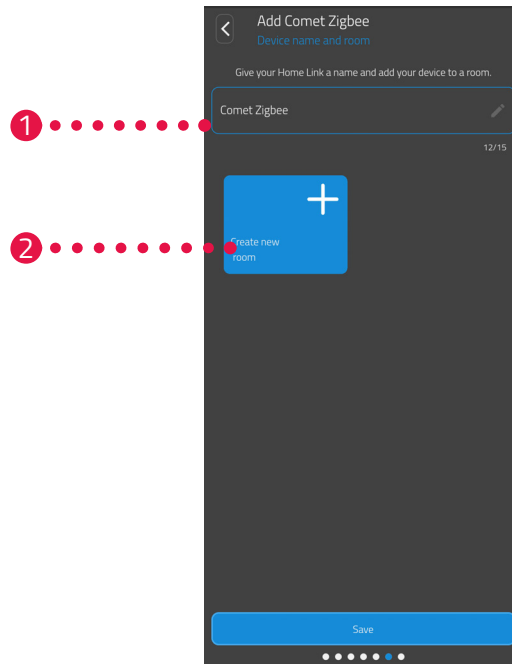

1. Enter a name for your Comet Zero ZigBee in the input field.
2. Tap on the **Create new room** button to create a room and assign your Comet Zero ZigBee to this room.



INFORMATION

When using several Comet Zero ZigBees, you can also assign the devices to existing rooms. It is not necessary to create a separate room for each Comet Zero ZigBee.

Comet Zero ZigBee -Starter Set- Putting into Operation

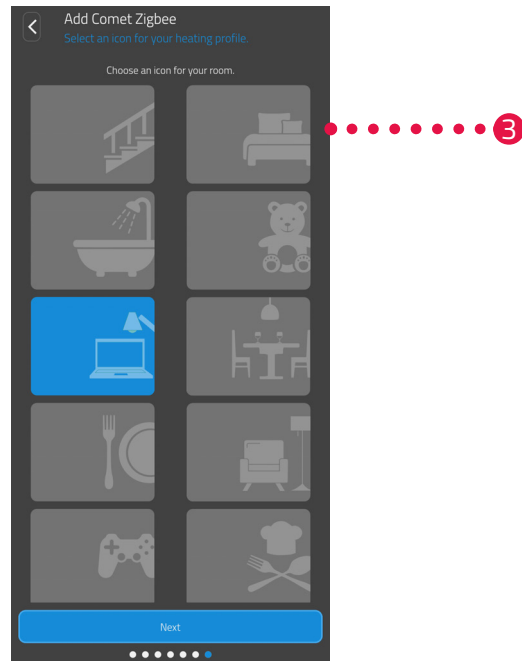

3. Select a symbol for the room.

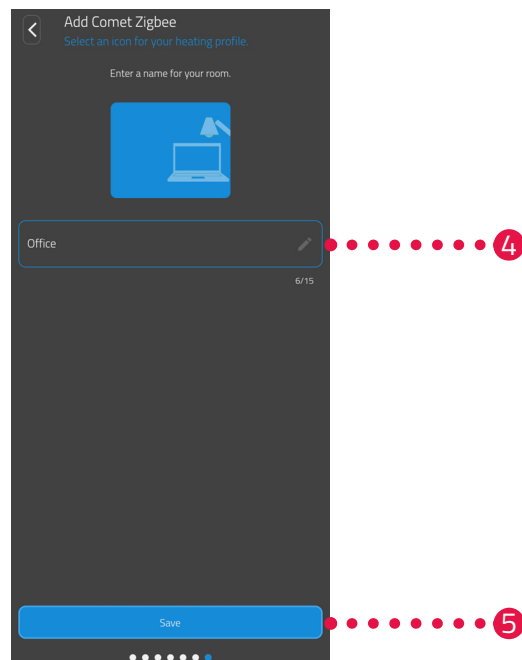

4. Enter a name for the room.

5. Tap the **Save** button.

→ You have named your Comet Zero ZigBee and assigned it to a room successfully.

→ Your Comet Zero ZigBee is now fully configured and ready to use.

6 OPERATION AND FUNCTIONS

When the device has been installed and started up successfully, you can define further settings in the **ET HomeLink** app.

From the start screen, you have access to the menu bar and all the rooms that have been configured.



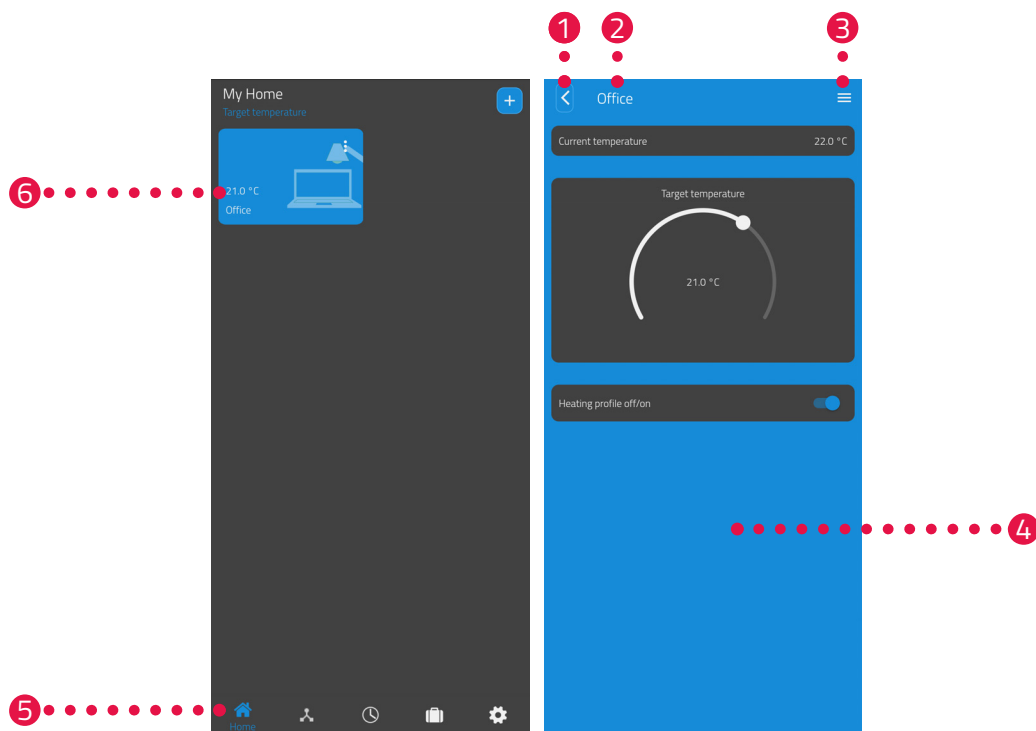

The following sections describe the operation and other functions of the ET Home Link gateway and Comet Zero ZigBee:

- Section 6.1: Operating the ET Home Link Gateway Using the App
- Section 6.2: Operating the Comet Zero ZigBee Using the App
- Section 6.3: Manual Operation of the Comet Zero ZigBee and Other Functions



- ① Back button
- ② Selected room
- ③ Room menu
- ④ Current display (e.g. room, device, etc.)
- ⑤ Menu bar
- ⑥ Selection of rooms (room tile)

The following functions are available in the menu bar:

- Start screen (My Home)
- Gateways, see  Section **6.1 Operating the ET Home Link Gateway on Page 41**
- Heating plans, see  Section **6.2.3 Heating profile on Page 47**
- Holiday plans, see  Section **6.2.4 Absence Plan on Page 51**
- Settings, see  Section **6.2.2 Device settings on Page 46**

The selection of rooms (room tiles) provides you with access to the associated Comet Zero ZigBee devices.

The following list contains a summary of the status symbols which could appear on the room tiles:



The battery of a Comet Zero ZigBee in the room is empty.



The room has been added to a heating profile. The heating profile is active.



The room has been added to a heating profile. The heating profile is inactive.



An adaptation error has occurred in one of the Comet Zero ZigBees in the room.

6.1 OPERATING THE ET HOME LINK GATEWAY

You can operate your ET Home Link gateway via the ET HomeLink app.

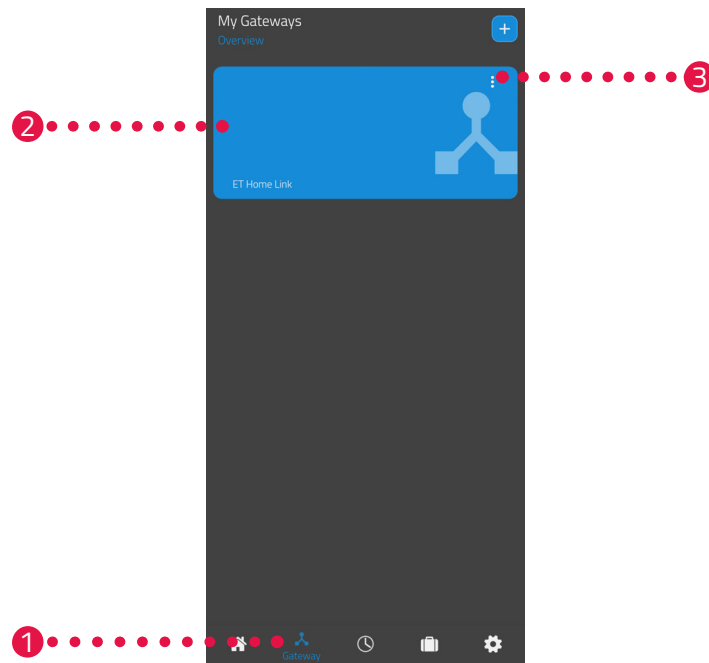

1. Tap on the **Gateway** menu option.
2. Tap on the tile of the ET Home Link gateway to open a detail view of the device with further information.

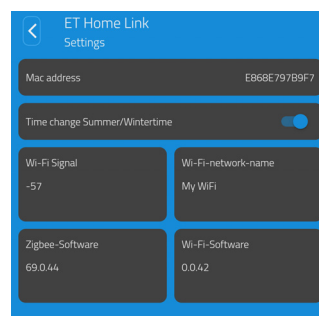

3. Tap on the Menu button.
→ An additional menu appears.

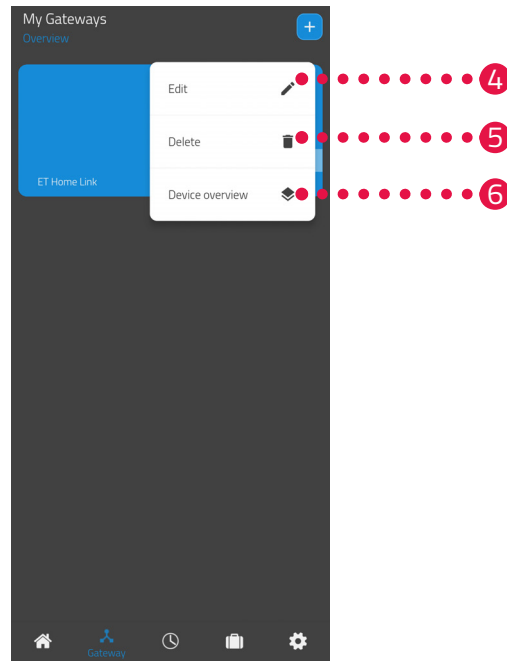

4. Tap on the **Edit** button in order to edit details of the ET Home Link gateway.
5. Tap on the **Delete** button to delete the ET Home Link gateway from the app.



INFORMATION

If you delete the ET Home Link gateway from the app, all the Comet Zero ZigBees connected via the app (and other devices connected) are also deleted from the app.

6. Tap on the **Device overview** button to open an overview of all devices connected via the ET Home Link gateway.

6.2 OPERATING THE COMET ZERO ZIGBEE

You can operate your Comet Zero ZigBee via the ET HomeLink app.

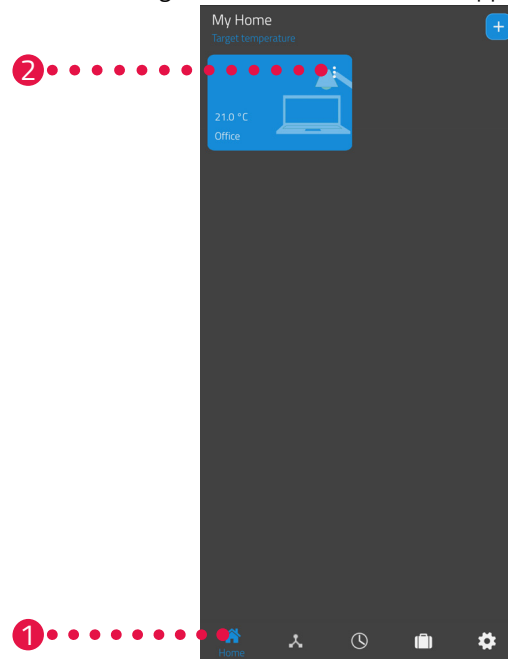

1. Tap on the **Home** menu option.
2. Tap on the Menu button.
→ An additional menu appears.

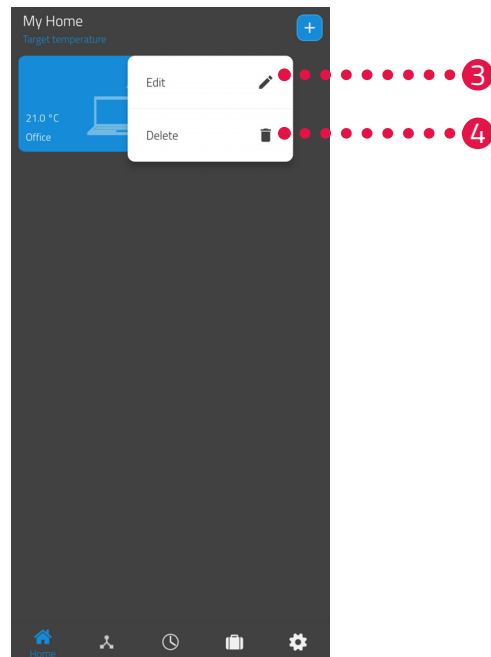

3. Tap on the **Edit** button to edit the name of the room.
4. Tap on the **Delete** button to delete the room.

6.2.1 SETTING TEMPERATURE IN A ROOM

You can set the temperature for each room individually. After selecting a room, set the desired temperature for the room or radiator.

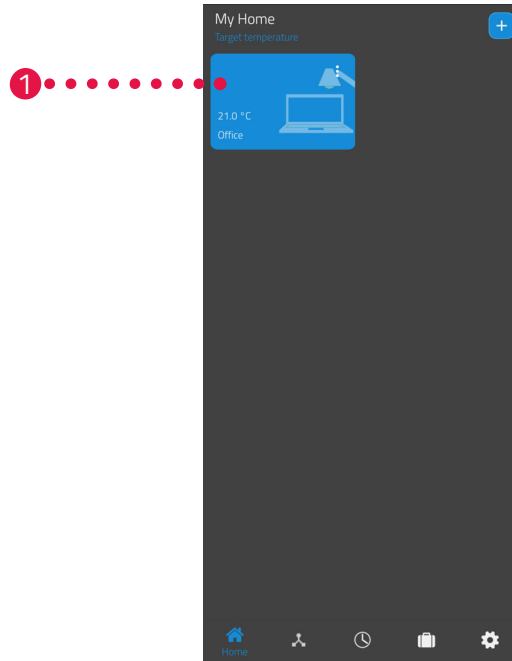

1. Tap on the desired room (e.g. office).
→ The current room temperature and the set temperature are displayed.

2. Make additional settings:

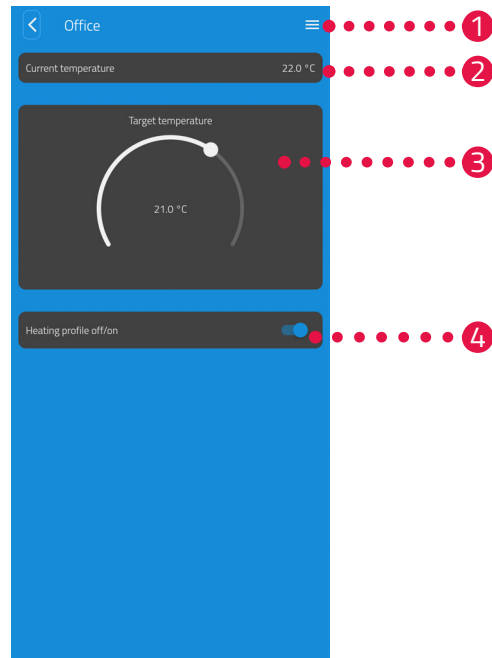

- 1 The menu displays all Comet Zero ZigBees that are assigned to the current room. You can define further settings for the selected Comet Zero ZigBee, see [📖 Section 6.2.2 Device settings on Page 46](#).
- 2 The **Current temperature** area displays the current temperature in the room.
- 3 Adjust the temperature individually with the setting wheel in the **Target temperature** area. The temperature selected is transferred to the Comet Zero ZigBee.

- 4 **Heating profile off:**
The stored heating profile is not active.
Heating profile on:
The stored heating profile is active. However, you can still make changes to the temperature. The temperature set manually is maintained until the next switching point. The Comet Zero ZigBee then switches to the set heating programme.



INFORMATION

Not all the functions shown are activated by default.

For additional information on the functions listed above, see [📖 Section 6.3 Further functions of the Comet Zero ZigBee on Page 55](#).

6.2.2 DEVICE SETTINGS

In the menu of a room (see  Section **6.2.1 Setting Temperature in a Room on Page 3.**) you have access to all the Comet Zero ZigBees assigned to the room. You have access to further settings and information regarding the selected Comet Zero ZigBee:

44

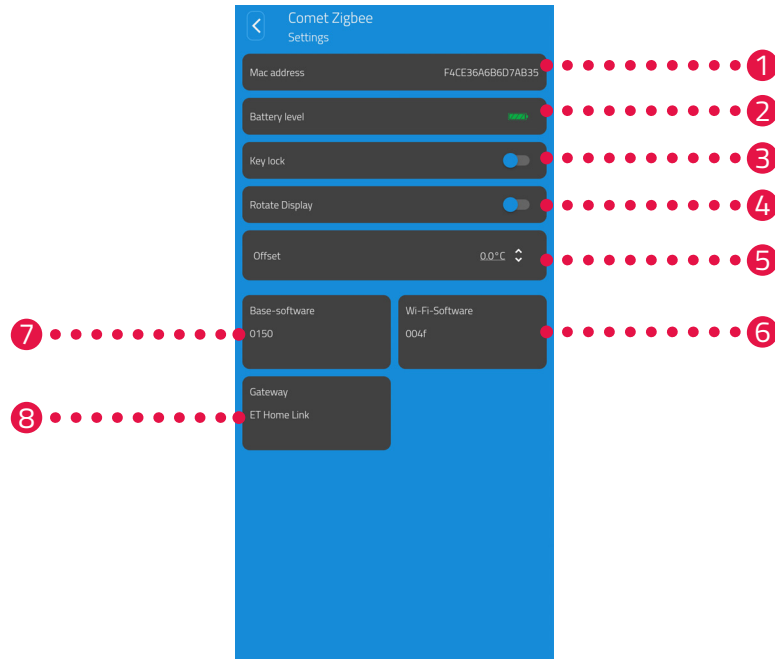

- 1 Mac address of the device
- 2 Current battery charge status
- 3 Activate/deactivate Key lock
- 4 Rotate display 180°
- 5 Carry out temperature adjustment
- 6 Version of the current Wi-Fi software
- 7 Version of current controller software
- 8 Name of the connected gateway



INFORMATION

Not all the functions shown are activated by default.
For additional information on the functions listed above, see  Section **6.3 Further functions of the Comet Zero ZigBee on Page 55.**

6.2.3 HEATING PROFILE

In the **Heating profile** menu, you set heating blocks with heating times for different days. You can set the temperature individually for each heating time.

CREATING A HEATING PLAN

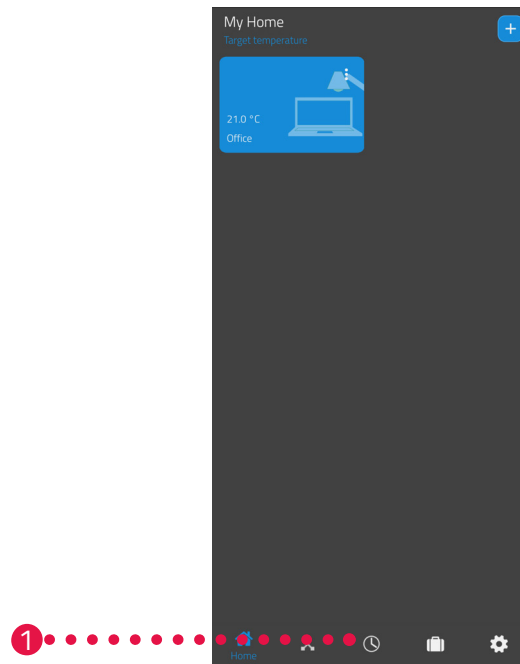

1. Tap on the **Heating plans** menu option.
→ The overview of the heating profiles is displayed.

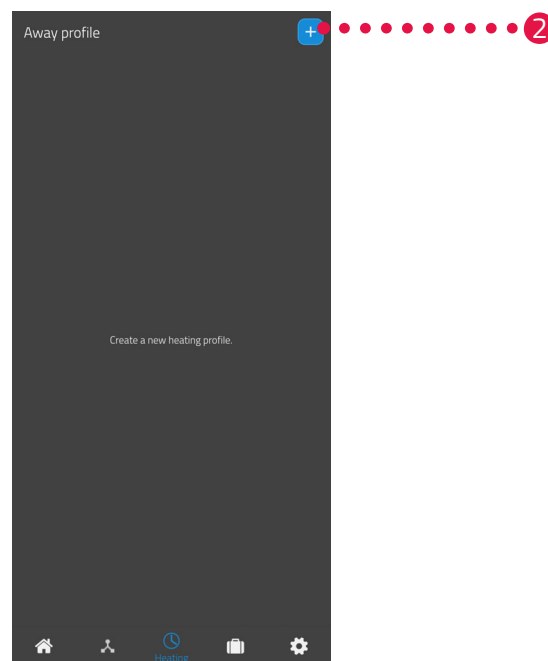

2. Tap the **+** button to create a new heating profile.
→ The overview of the available rooms is displayed.

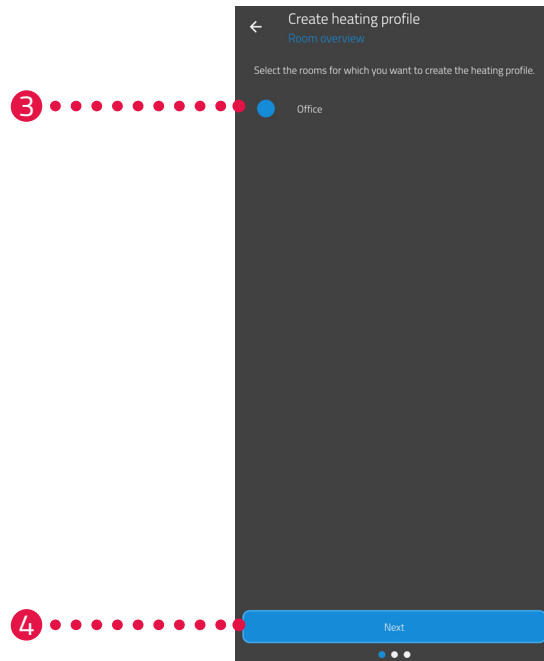

3. Tap on one or more rooms for which the heating profile is to apply.
4. Tap the **Next** button.
5. Enter a designation for the heating profile in the input field.
6. Tap the **Next** button.

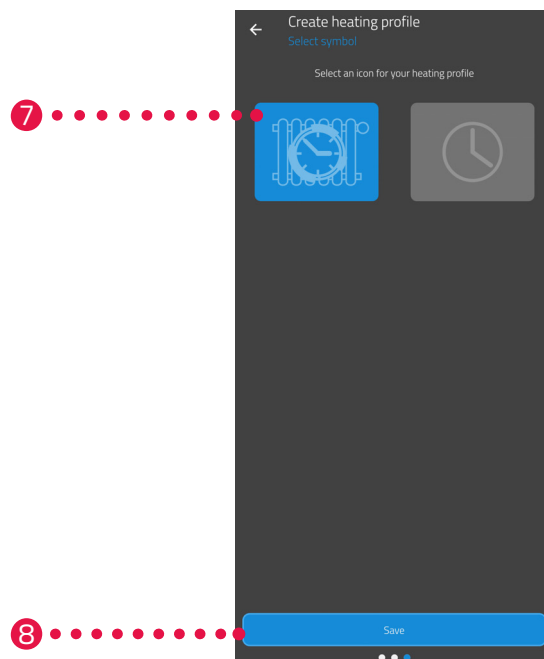

7. Select a symbol for the heating profile.
8. Tap the **Save** button.
→ You have successfully created the heating profile.

EDITING OR DELETING A HEATING PLAN

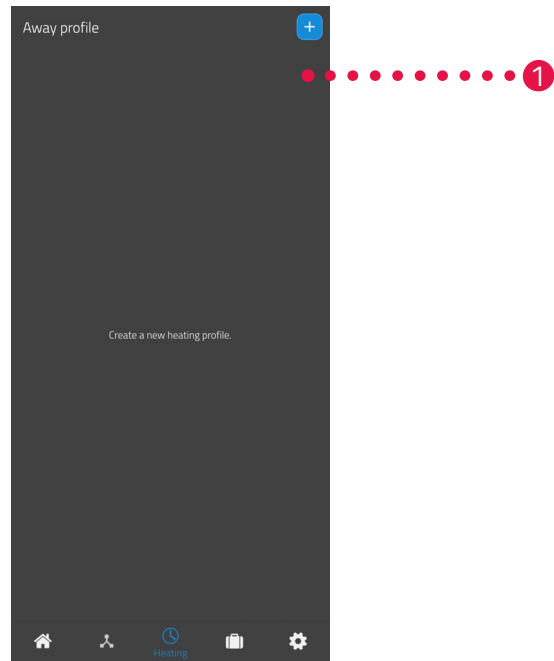

1. Option: Tap on the Menu button.
→ An additional menu appears.

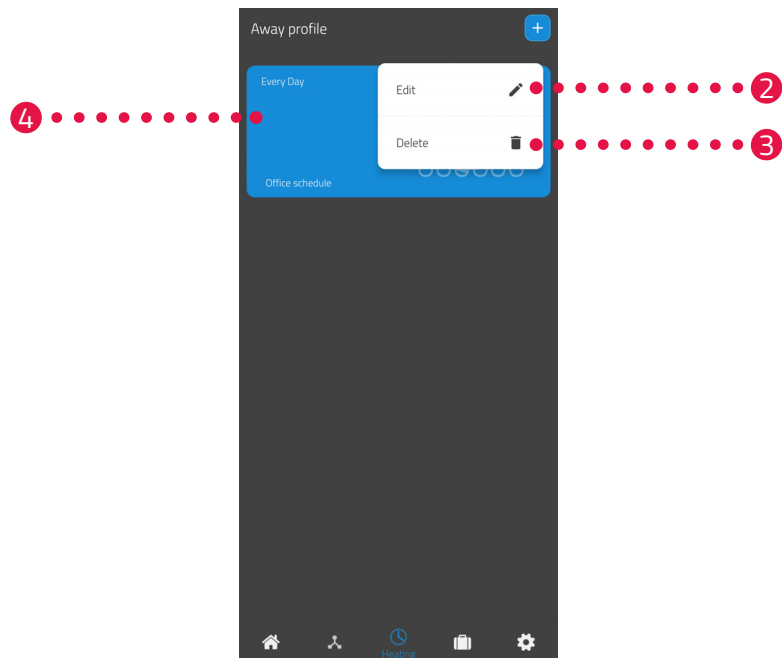

2. Tap on the **Edit** button to edit the details of the heating plan.
3. Tap on the **Delete** button to delete the heating plan.
4. Tap the **heating profile** to set the heating times:

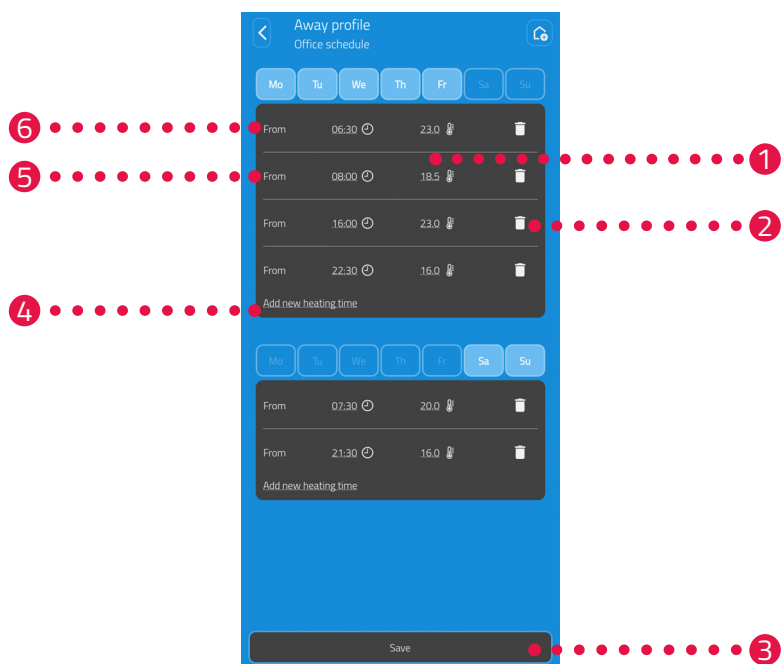

- 1 Set the target temperature for the selected switching point.

2 Delete the selected heating time.

3 Save the settings.
- 4 Add a new heating time.

5 Set the starting time of the selected heating time.

6 Select the period of the current heating block.



INFORMATION

Note that the settings are only transferred to the corresponding Comet Zero ZigBee, and thus activated, by tapping on the **Save** button.

6.2.4 ABSENCE PLAN

Use the **Away** menu to define a holiday plan for a period of absence. You can set the temperature individually for each switching point.



1. Tap on the **Away** button.
2. Tap on the **+** button to create a new absence plan.
→ The overview of the available rooms is displayed.

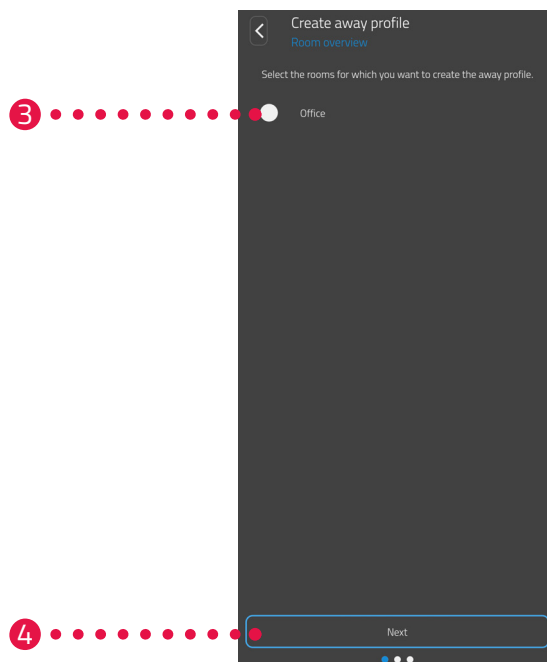

3. Tap on one or more rooms for which the absence plan should apply.
4. Tap the **Next** button.

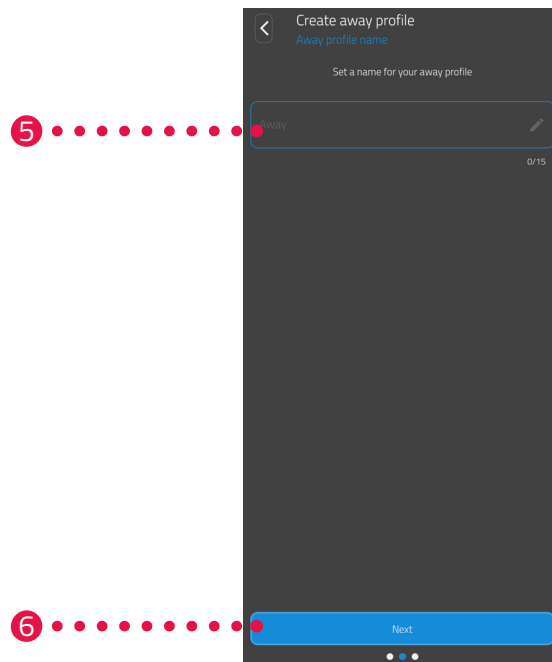

5. Enter a name for the absence plan in the input field.
6. Tap the **Next** button.

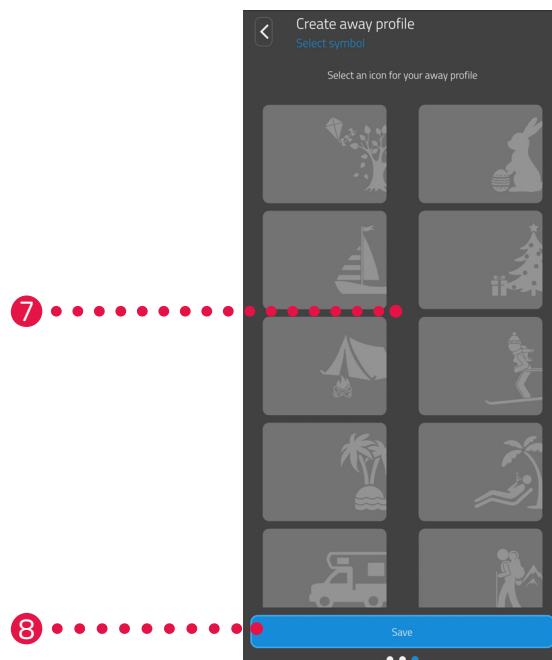

7. Select a symbol for the absence plan.
8. Tap the **Save** button.

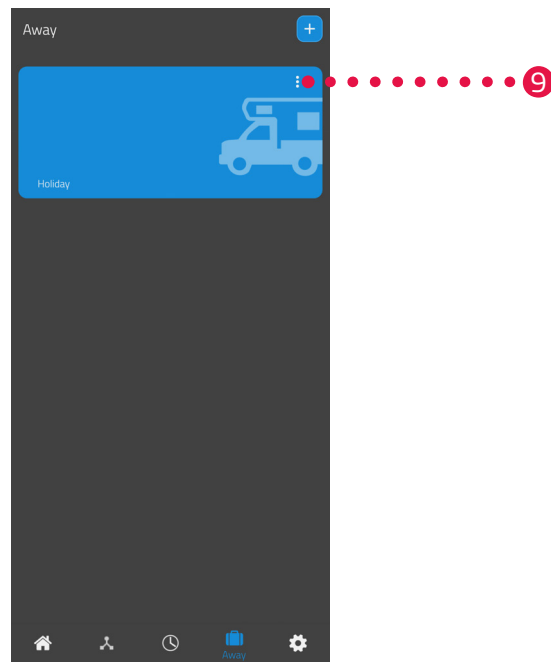

9. Option: Tap on the Menu button.
→ An additional menu appears.

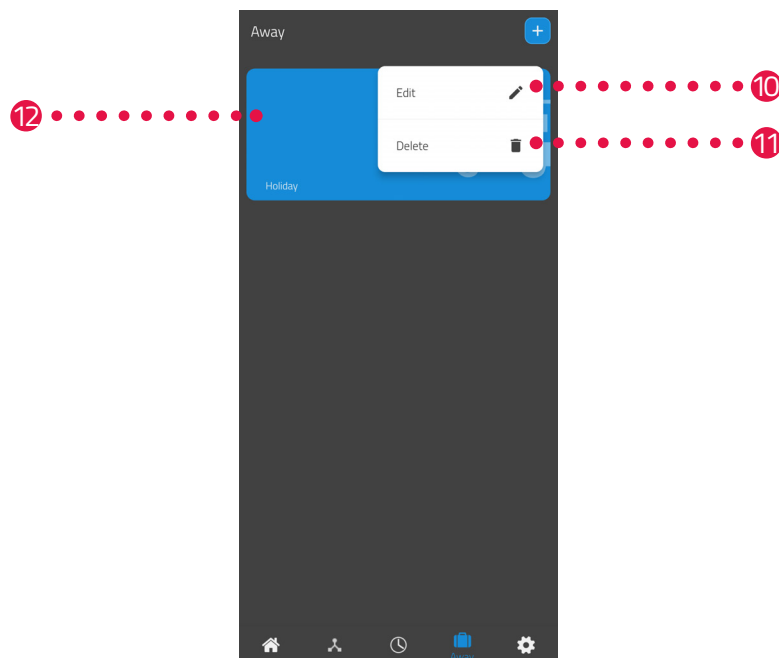

10. Tap on the **Edit** button to edit the details of the absence plan.
11. Tap on the **Delete** button to delete the absence plan.
12. Tap on the **Away disabled/enabled** button to set the heating times:

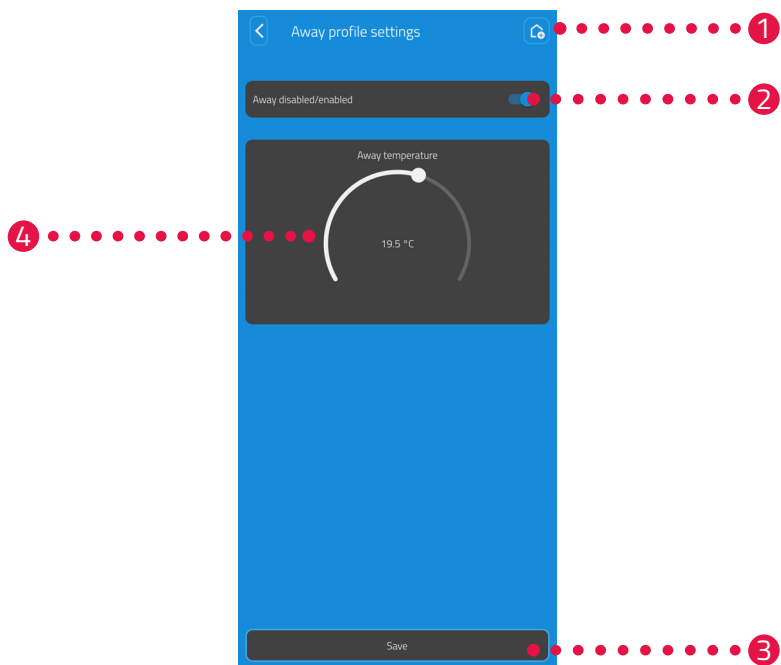

- 1 Overview of which rooms should be assigned to the holiday plan.
- 2 **Activate/Deactivate** the holiday plan.
- 3 Save the settings.
- 4 Set the **Away temperature** for the period of absence.



INFORMATION

Note that the settings are only transferred to the corresponding Comet Zero ZigBee, and thus activated, by tapping on the **Save** button.



INFORMATION

The temperature can be adjusted manually at any time. The heating plan is not interrupted by adjusting the temperature.

6.3 FURTHER FUNCTIONS OF THE COMET ZERO ZIGBEE

MANUAL OPERATION

It is possible to change the temperature manually using the buttons on the Comet Zero ZigBee. The temperature range is between 8 - 28 °C. the temperature is increased or reduced beyond the limits, the Comet Zero ZigBee switches to Boost mode of Off mode.

Manual adjustment of the temperature sets the Comet Zero ZigBee to Heating mode.

CHANGING OPERATING MODES

Off mode: Press the **- button** until -- appears in the display. The heater valve is closed fully.

Heating mode: If you change the target temperature using the **+ button** or **- button**, the Comet Zero ZigBee switches to Heating mode.

Boost mode: Press the **+ button** until ON appears in the display. The heater valve is opened fully.

OFFSET (TEMPERATURE ADJUSTMENT)

If the temperature felt differs from the set temperature, you can perform a temperature adjustment. Adjust the settings as necessary using the ET HomeLink app, see  Section **6.2.2 Device settings on Page 46**.

ALIGN DISPLAY

Depending on the positioning of your radiator valve, it may be necessary to turn the display of your Comet Zero ZigBee by 180°. Adjust the settings as necessary using the ET HomeLink app, see  Section **6.2.2 Device settings on Page 46**.

FROST AND LIMESCALE PROTECTION

The frost protection and limescale protection functions are automatically active.

Frost protection

If the temperature in a room drops below 6° C, the frost protection function of the Comet Zero ZigBee is automatically activated. -- appears in the display. In this case, the Comet Zero ZigBee opens the valve until the temperature rises above 8°C. This prevents the radiators from freezing.

Lime protection

To prevent the radiator valves from calcifying, your Comet Zero ZigBee executes the limescale protection function every Friday at 11:00.

KEY LOCK

Activate the key lock directly on your Comet Zero ZigBee:

1. Press and hold the **+ button** and **- button** simultaneously for 3 seconds.
→ An animation is shown on the display.
2. To deactivate, press and hold the **+ button** and the **- button** simultaneously for a few seconds. Wait until the animation on the display disappears.

6.4 DISCONNECTING THE ZIGBEE CONNECTION

It may become necessary to disconnect the connection between the Comet Zero ZigBee and ET Home Link gateway.

Ensure that the following condition is fulfilled:

- The batteries have been inserted in the Comet Zero ZigBee.
1. Open the **ET HomeLink** app on your smartphone.

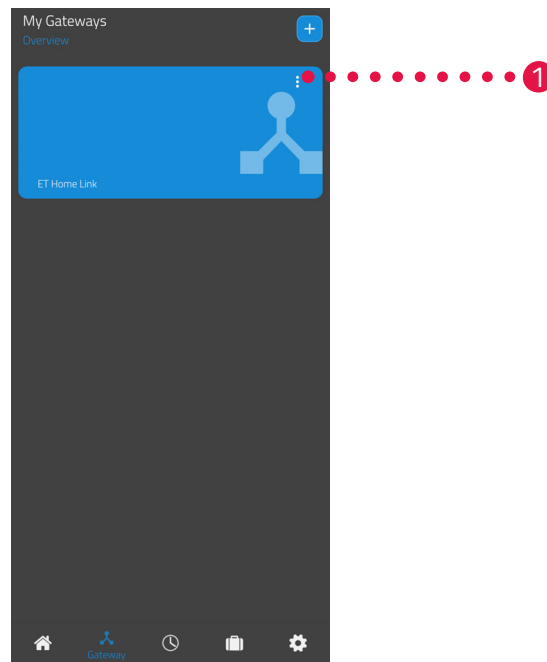

2. Tap on the Menu button.
→ An additional menu appears.

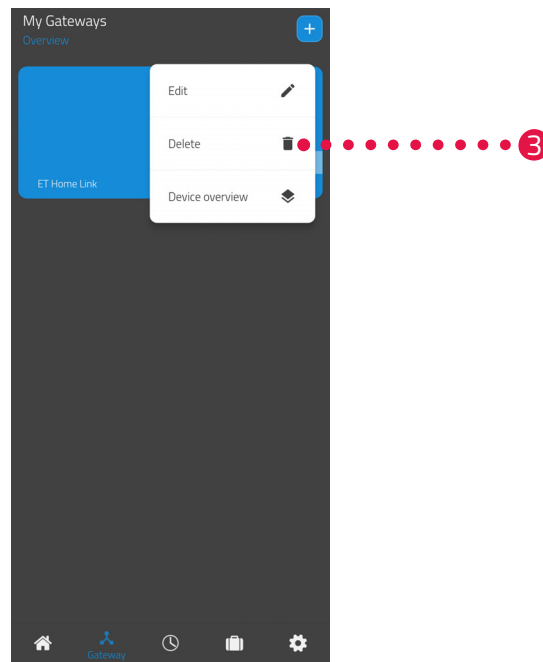

3. Tap on the **Delete** button.
 - The connection to the ET Home Link gateway is disconnected.
 - **PA** appears in the display of the Comet Zero ZigBee.



INFORMATION

If **Er** appears in the display, repeat the process.

6.5 RESETTING THE DEFAULT FACTORY SETTINGS



INFORMATION

Please note that the devices continue to be listed in the ET HomeLink app after resetting the default factory settings but no connection is possible. Remove the devices from the app manually.

COMET ZERO ZIGBEE

If problems occur, it may be helpful to reset your Comet Zero ZigBee to the factory settings.

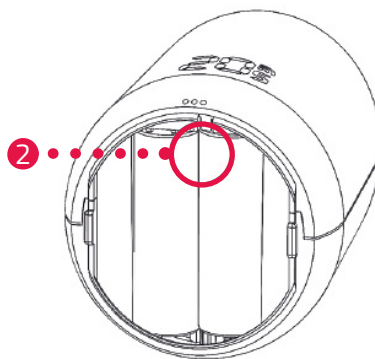

1. Open the battery compartment cover.
2. Press and hold the **Reset button** located in the battery compartment.
→ LE appears in the display after 5 seconds.
3. Keep the **Reset button** in the battery compartment pressed in.
→ A timer appears in the display which counts up to 10 after which the display is clear
4. Release the **Reset button** located in the battery compartment.
→ You have now reset your Comet Zero ZigBee to its factory settings.
→ PA appears in the display, the Comet Zero ZigBee is in pairing mode.

ET HOME LINK GATEWAY

Should problems occur, it may help to reset the ET Home Link gateway to its default factory settings.

1. Press and hold the **Reset button** on the rear side for 5 seconds.
→ Die Wi-Fi LED and ZigBee LED light up red and the gateway is reset.
→ The Wi-Fi LED flashes green, the ZigBee LED lights up green continuously.
→ You have now reset your ET Home Link gateway to its default factory settings.
→ Your ET Home Link gateway is now in configuration mode.

7 DISASSEMBLY

If necessary, you can disassemble the Comet Zero ZigBee from the radiator valve.

Ensure that the following conditions are fulfilled:

- The batteries have been inserted in the Comet Zero ZigBee.
- The connection to the ZigBee controller has been disconnected, see  Section **6.4 Disconnecting the ZigBee Connection on Page 56**.
- PA appears in the display.



CAUTION!:

Burns caused by hot radiator valve!

Touching can cause burns to the hand.

- ➔ Do not touch hot radiator valves!
- ➔ Allow the radiator to cool down before installing, removing or servicing your Comet Zero ZigBee!

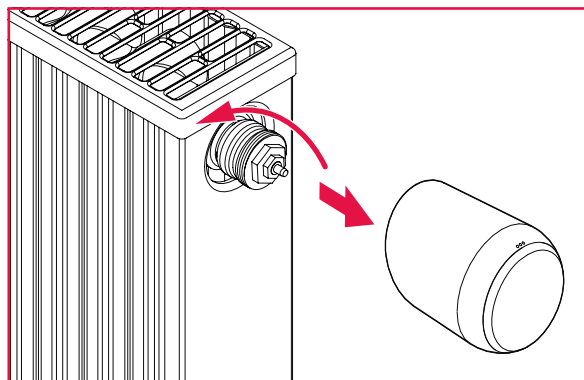

1. Turn the union nut anti-clockwise.
2. Pull the Comet Zero ZigBee from the radiator valve (see illustration).
 - ➔ The Comet Zero ZigBee has been disassembled.

8 TROUBLESHOOTING

Problems can arise with the Comet Zero ZigBee. The following information will help you clear any errors.



INFORMATION

The list below describes errors in the Comet Zero ZigBee. In the case of errors with the ET Home Link gateway, observe the information on the control lamps, see Section **4.3 ET Home Link Gateway Display Elements on Page 14**.

Problem	Cause	Remedy
	Pairing with the ZigBee controller has failed.	<ul style="list-style-type: none"> Pressing any button clears the error indicator in the display and Configuration mode is restarted. PA appears in the display first, then and countdown starts.
The radiator does not heat up.	The boiler water temperature is too low or the radiator valve could be calcified and, as a result, cannot open.	<ul style="list-style-type: none"> Raise the boiler water temperature. Disassemble the Comet Zero ZigBee. Move the valve plunger in and out with an appropriate tool to loosen any calcification. Finally, assemble the Comet Zero ZigBee on the radiator valve again.
The radiator does not cool down.	The radiator valve does not close fully. It is possible that the closing point of the valve seal has moved.	<ul style="list-style-type: none"> Disassemble the Comet Zero ZigBee. Move the valve plunger in and out several times with an appropriate tool to loosen any calcification. Finally, assemble the Comet Zero ZigBee on the radiator valve again.
The pressure piece drops out.	If your Comet Zero ZigBee is not installed on the valve, the pressure piece fitted on the underside can fall out of the endless thread.	<ul style="list-style-type: none"> Remove the batteries from the Comet Zero ZigBee. Insert the pressure piece in the Comet Zero ZigBee. Insert the batteries in the Comet Zero ZigBee.
ER, E1-E3	Pressing any button clears the error indication in the display and the adaptation restarts.	
	Disconnection (exclusion) from the ZigBee controller has failed.	<ul style="list-style-type: none"> Set the ZigBee controller to disconnection mode. Ensure that the Comet Zero ZigBee is within range of the ZigBee controller.
	The radiator valve is not installed or not detected.	<ul style="list-style-type: none"> Press any button to confirm. Ensure that the Comet Zero ZigBee has been installed correctly on the radiator. Use the appropriate adapter.
	The valve cannot be moved or the radiator valve jams.	<ul style="list-style-type: none"> Ensure that the Comet Zero ZigBee has been installed correctly on the radiator and the valve plunger can move freely.

Problem	Cause	Remedy
	The batteries are weak.	<ul style="list-style-type: none"><li data-bbox="794 434 1070 465">▪ Change the batteries.

9 CLEANING AND STORAGE

Switch the Comet Zero ZigBee off and remove the batteries if you will not be using your Comet Zero ZigBee for a longer period of time.

Disconnect the ET Home Link gateway from the power supply if you will not be using the ET Home Link gateway for a longer period of time.

Store the Comet Zero ZigBee and ET Home Link gateway in a dry, dust-free location.



IMPORTANT!

Material damage possible!

Improper handling of the Comet Zero ZigBee and ET Home Link gateway can lead to damage.

- ➔ Do not immerse your Comet Zero ZigBee and ET Home Link gateway in water or other liquids.
- ➔ Do not use any brushes with metal or nylon bristles or sharp or metallic cleaning tools such as knives, hard spatulas and such. They can damage the surfaces.
- ➔ Clean the Comet Zero ZigBee and ET Home Link gateway with a soft, dry, lint-free cloth.
- ➔ Do not use cleaning agents or solvents.

10 APPENDIX

The following sections contain information on technical data, customer service and other legal information.

10.1 TECHNICAL DATA

The list below contains technical data concerning the ET Home Link gateway:

Designation	ET Home Link gateway
Article number	700256
Supply voltage	Micro USB, 5 V
Connection protocol	ZigBee 3.0, Wi-Fi
Radio frequency	ZigBee: 2.4 GHz Wi-Fi: 2400 MHz ~ 2483.5 MHz
Maximum transmission power	ZigBee: 8 dBm IEEE 802.11b: 19 dBm IEEE 802.11g: 19 dBm (6 Mbps) IEEE 802.11g: 15 dBm (54 Mbps) IEEE 802.11n: 19 dBm (MSC0) IEEE 802.11n: 15 dBm (MSC7)
Reception range	70 m
Controllable devices	60
Dimensions	68 × 68 × 24 mm
Weight	40 g

The list below contains technical data concerning the Comet Zero ZigBee:

Designation	Comet Zero ZigBee
Article number	700251
EAN number	4260012712551
Supply voltage	2 × batteries, 1.5 V AA/LR6
Threaded connection	M30 × 1.5 mm
Method of operation	Type 1
Dimensions	62 × 68 × 83 mm
Weight	230 g (incl. batteries)
Protection class	IP 20
Degree of contamination	2
Connection protocol	ZigBee 3.0
Radio frequency	2.4 GHz
Maximum transmission power	+8 dBm

Subject to technical changes at any time. Compatibility information provided without guarantee.

10.2 ADAPTER OVERVIEW

The following overview contains information about the valves and the required adapters. The adapters for Danfoss RAV, Danfoss RA and Danfoss RAVL are included with your Comet Zero ZigBee. When using the Danfoss RAV adapter, the RAV pin must be inserted on the valve plunger.

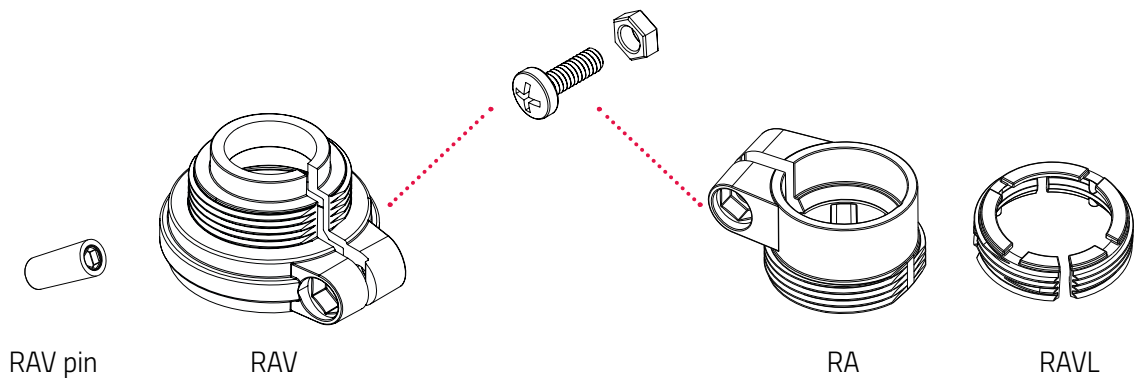

Valve	Thread dimension	Adapter
Heimeier	M30 × 1.5 mm	Not required
Junkers Landys+Gyr	M30 × 1.5 mm	Not required
MNG	M30 × 1.5 mm	Not required
Honeywell	M30 × 1.5 mm	Not required
Braukmann	M30 × 1.5 mm	Not required
Herz	M28 × 1.5 mm	Required; not in scope of delivery
Comap	M28 × 1.5 mm	Required; not in scope of delivery
Vaillant	30.5 mm	Required; not in scope of delivery
Oventrop	M30 × 1.0 mm	Required; not in scope of delivery
Meges	M38 × 1.5 mm	Required; not in scope of delivery
Ondal	M38 × 1.5 mm	Required; not in scope of delivery
Giacomini	22.6 mm	Required; not in scope of delivery
Rosswainer	M33 × 2.0 mm	Required; not in scope of delivery
Markaryd	M28 × 1.0 mm	Required; not in scope of delivery
Ista	M32 × 1.0 mm	Required; not in scope of delivery
Vama	M28 × 1.0 mm	Required; not in scope of delivery
Pettinaroli	M28 × 1.5 mm	Required; not in scope of delivery
T+A	M28 × 1.5 mm	Required; not in scope of delivery
Gampper 1/2/6	M20	Required; not in scope of delivery
Danfoss RA/RAV/RAVL	25.5/30.5/30 mm	Included in scope of delivery



INFORMATION

Remove the connecting pieces of the plastic adapters (see illustration) before using one of the adapters included. Use the screw and nut enclosed when using the Danfoss RAV and Danfoss RA adapters.

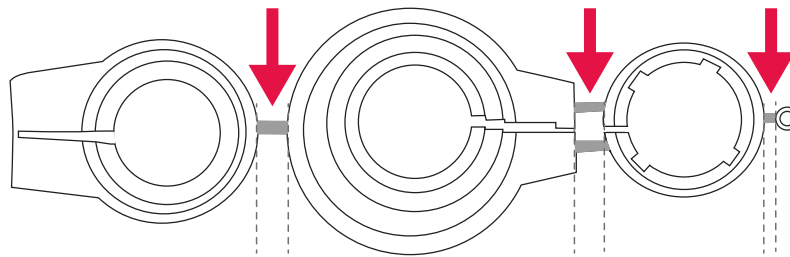

CAUTION!:

Danger of being cut!

The adapters supplied and the plunger extension are connected by plastic bars. Fractures may be sharp-edged.

→ Be careful not to cut your fingers during installation!



CAUTION!:

Danger of becoming trapped between the adapter halves!

Carelessness when using adapters can lead to injuries.

→ Take care not to become trapped between the adapter halves during installation!

You can purchase further metal adapters for a fee from our partners. You will find an overview of the metal adapters and corresponding ordering options under the following link:

<https://eurotronic.org/produkte/zubehoer/metalladapter/>

10.3 SUPPORT AND CONTACT

You can contact us for technical support.
We look forward to assisting you with your enquiry:

Phone: +49-(0)-6667-91847-0
E-mail: support@eurotronic.org
Customer service: **EUROtronic Technology GmbH**
Südweg 1
36396 Steinau-Ulmbach
Germany

10.4 DISPOSAL



INFORMATION

Please inform yourself about the options for returning old devices and used batteries free of charge at your retailer.

From the date of implementation of the European Directives 2012/19/EU into national law, the following applies:

Remove the batteries before disposing of your Comet Zero ZigBee.



The adjacent symbol indicates that electrical and electronic apparatus no longer required must be disposed of separate from domestic waste in accordance with legal directives. Dispose of the device at a collection point provided by your municipal waste authorities.



Batteries must not be disposed of in household waste! Defective or spent batteries must be recycled according to Directive 2006/66/EC. Return batteries and / or the device via the recycling services offered.

DISPOSAL OF PACKAGING:



Observe the identifications on the packaging when sorting the waste materials; the identifications are comprised of abbreviations (a) and numbers (b) and have the following significance: 1–7: plastics / 20–22: paper and cardboard / 80–98: composite materials.



Dispose of the packaging according to type. Dispose of cardboard and carton at waste paper collection points and foil at recyclables collection points. The symbols on your Comet Zero ZigBee, the operating instructions or the packaging refer to these regulations. With recycling, material recovery or other forms of recovery of used devices/batteries, you make an important contribution to the protection of our environment.

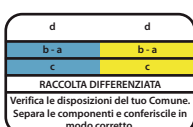

The logo only applies to Italy.

10.5 PERSONAL DATA

Delete all personal data from your user account for the ET HomeLink app before disposing of your Comet Zero ZigBee or ET Home Link gateway.

10.6 SIMPLIFIED DECLARATION OF CONFORMITY

CE EUROtronic Technology GmbH hereby declares that the radio equipment types ET Home Link gateway and Comet Zero ZigBee comply with the Directive 2014/53/EU. The entire text of the EU Declaration of Conformity is available at the following Internet address: <https://eurotronic.org/service/downloads>

10.7 WARRANTY NOTICE

The warranty period is 24 months and begins on the day of purchase. Keep your receipt as proof of purchase. During the warranty period, defective energy-saving controllers can be sent to the service address with sufficient postage. To do this, contact our Customer Service before returning the item. You will then receive a new or repaired device in return free of charge. Receipt of a repaired or replacement of the device does not begin a new warranty period. Please note that we guarantee the functions of the device, not the functionality between the interaction of the device and the valve base.

The application-related technical data is only guaranteed together with the valves Heimeier, Junkers Landys+Gyr, MNG, Honeywell Braukmann thread dimension (M30x1.5), Oventrop (M30x1.5) Danfoss RA, RAV and RAVL. The device combinations can be viewed at our website (<https://eurotronic.org/service/faq>). If you operate the Comet Zero ZigBees with third-party valves/adapters that are not listed, the reliability of the functions must be ensured by the user. EUROtronic does not provide warranty service in these cases.

After the warranty period has expired, you retain have the option of sending the device to the address provided for repair, ensuring sufficient postage. Repairs required after the expiration of the warranty period are subject to a charge. Your statutory rights are not limited by this warranty.

| 10.8 MANUFACTURER

EUROtronic Technology GmbH

Südweg 1
36396 Steinau-Ulmbach
Germany

+49 (0) 6667 91847-0
support@eurotronic.org
www.eurotronic.org



EUROtronic Technology GmbH
Südweg 1 | 36396 Steinau-Ulmbach | Germany
www.eurotronic.org