

Comet Z-Wave™

ENERGY-SAVING RADIATOR THERMOSTAT
WITH Z-WAVE



MADE IN
GERMANY 

 **EUROTRONIC**
Technology GmbH



CONTENT

1	Delivery scope	3
2	Warnings	4
3	Introduction of Comet Z-Wave	5
4	Control and display elements	5
	4.1 Buttons	5
	4.2 LED-lights	6
5	Installation	7
	5.1 Insert batteries	7
	5.2 Set up into a Z-Wave network	8
	5.3 Mounting at radiator	9
	5.4 Adapters	9-10
	5.5 Adaption	10-11
	5.6 Delete a device out of a Z-Wave network	11
	5.7 Dismounting Comet Z-Wave	12
	5.8 Factory reset	12
6	Operating the device	13
	6.1 Setting the target temperature	13
	6.2 Child protection / Key lock	13
	6.3 Changing the operating mode	13
	6.4 Window open detection	13
	6.5 Display Node ID	13
7	Operating Z-Wave	14
	7.1 Assoziation	15
	7.2 Basic	15
	7.3 Configuration	16
	7.4 Multilevel sensor	16
	7.5 Multilevel switch	17
	7.6 Notification	17
	7.7 Child protection / Key lock	17
	7.8 Thermostat Mode	17
	7.9 Thermostat Setpoint	18
8	Errors and messages help	18
9	Cleaning and storage	19
10	Technical specification	19
11	Support and contact	19
12	Warranty	20
13	Legal information	20

1. DELIVERY SCOPE

- 1x Comet Z-Wave Energy saving radiator
- 1x Quick Start Guide
- 3x Adapter for Danfoss Ventile (Danfoss RA / RAV / RAVL)
- 1x Screw for adapter
- 2x LR6/Mignon/AA batteries

NOTE: The illustrations below are for illustrative purposes only and may differ from the actual product.

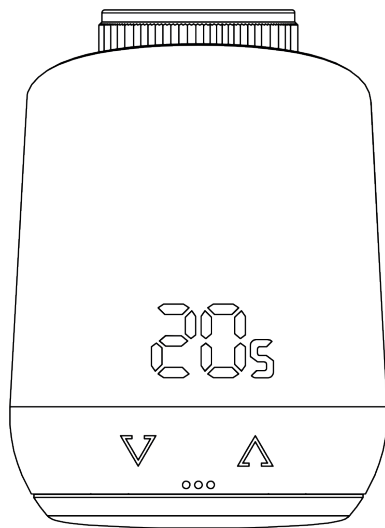

Comet Z-Wave
Energy saving radiator

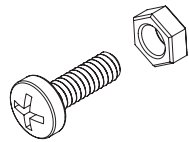

Screw for
adapter

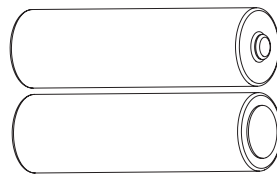

2x batteries AA LR6

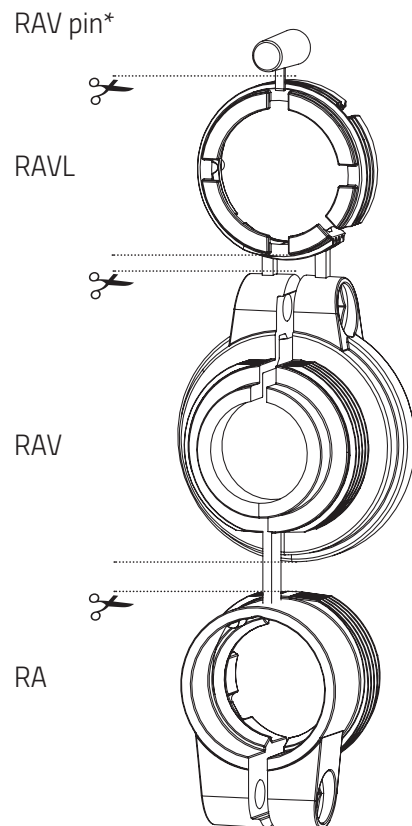

* When using the RAV adapter, you need the RAV pin to extend the valve tappet.

NOTE: Check the scope of delivery for completeness and intactness.

2. WARNINGS

WARNING!

This signal word designates a hazard with a medium level of risk which, if not avoided, can result in death or serious injury.

A NOTICE! This signal word warns of possible damage to property.

Safety notice

- Comet Z-Wave is intended for indoor use.
- Operate Comet Z-Wave only as described in the user manual.
- Comet Z-Wave should only be stored in a dry and dust-free place out of direct sunlight be put into use.
- Do not continue to operate the device if it shows obvious damage.
- Comet Z-Wave may not be rebuilt, modified or opened.

WARNING! EXPLOSION HAZARD!

Improper handling of batteries can cause an explosion.

- Do not heat batteries and do not throw batteries into open fire.
- Do not place batteries in direct sunlight.
- Protect batteries from excessive heat.
- Do not short-circuit the batteries.
- Never try to charge non-rechargeable batteries.
- Never disassemble batteries.
- Do not mix new and used batteries.
- Observe the correct polarity (+/-) when inserting the batteries.
- Before inserting the batteries, clean the batteries and the contacts in the thermostat.

WARNING! RISK OF BURNS!

Leaking battery acid can cause burns.

- Avoid contact of battery acid with skin, eyes and mucous membranes.
- In the event of contact with battery acid, immediately rinse the affected areas with plenty of clear water and see a doctor.

WARNING! RISK OF INJURY!

If children play with the thermostat or the packaging, they can swallow small parts and choke.

- Do not let children play with the thermostat or the packaging.
- Keep batteries away from children. Consult a doctor immediately if batteries were swallowed.

3. INTRODUCTION OF COMET Z-WAVE

Comet Z-Wave is an energy-saving radiator controller compatible with the Z-Wave wireless standard.

FLiRS (Frequently Listening Receiver Slave):

Comet Z-Wave uses the Z-Wave function FLiRS as a radiator thermostat. As a FLiRS device, the radiator thermostat reacts to incoming commands such as temperature changes with a particularly short latency period.

4. CONTROL- AND DISPLAY ELEMENTS









4.1 BUTTONS



Minus



Plus

Button	Action	Meaning
	short push	Decrease target temperature for 0,5°C
	press and hold	Decrease target temperature for 0,5°C, then decrease by 0.5°C every 0.5 seconds as long as the button is pressed or the end value is reached.
	short push	Increase target temperature for 0,5°C
	press and hold	Increase the target temperature immediately by 0.5°C, then increase by 0.5°C every 0.5 seconds as long as the button is pressed or the end value is reached.
Button in battery compartment	press and hold for 3 seconds	The display shows the network identifier (Z-Wave NodeID).
Button in battery compartment	press and hold for 5 seconds	Comet Z-Wave reacts to remove commands from the gateway. (Exclusion)
Button in battery compartment	press and hold for 10 seconds	The device gets a factory reset.
 & 	press and hold both for 3 seconds	Activate or deactivate key lock/child lock.
 & 	when displayed „Ad“ press and hold both for 3 seconds	Adaptation get started

4.2 LED-LIGHTS



Radio symbol:

Informs about radio connection and adding operations.
Is switched on when radio connection is established.
Turns off when radio connection is lost.



Pairing mode (Inclusion) active.



Exclusion mode active.



Adaptation must be started.



Animation: Lights up while adaptation is running.



Animation: Lights up when the key lock is activated/deactivated.



Lights up when the battery level is less than 25%.



Removal operation (Exclusion) failed.



No valve movement possible .



No valve detected.



Closing point not detected.



Add operation (Inclusion) failed.

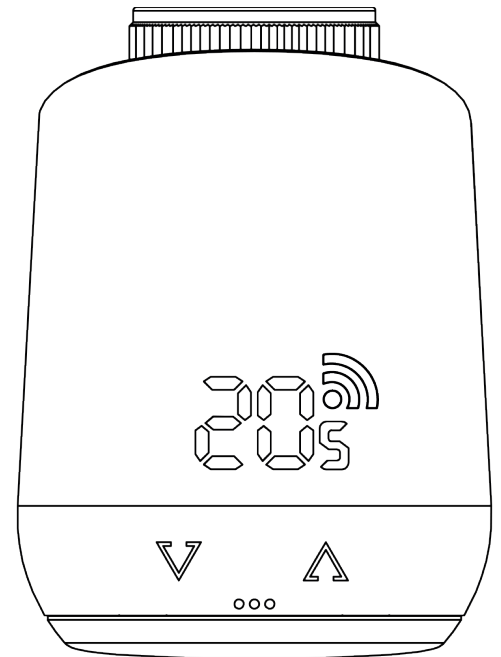

5. INSTALLATION

The Comet Z-Wave does not belong to any Z-Wave network ex works. The Comet Z-Wave must be added to an existing network in order to communicate with other Z-Wave devices. This process is called inclusion. The Comet Z-Wave can also leave a network. This operation is called removal (exclusion). Both operations must be initiated by a primary Z-Wave controller. To do this, the controller must be put into Add or Remove mode. Please refer to the user manual of your Z-Wave controller how to start the modes. Only when the primary controller is in add/remove mode, Z-Wave devices can join or leave the network. If the device already belongs to a network, the device must first be removed from the network. Otherwise, the join attempt will fail.

Behavior in the Z-Wave network

The Comet Z-Wave can be added to any Z-Wave network and operate with other Z-Wave certified devices and/or applications from other manufacturers. All non-battery powered network nodes (nodes), regardless of manufacturer, act as repeaters within the network and improve the reliability of the wireless network.

Network security

Comet Z-Wave can communicate encrypted with other Z-Wave devices, if they also support encrypted communication. If this is not the case, Comet Z-Wave communicates unencrypted.

NOTE: To use the full functionality of the Comet Z-Wave, a security enabled Z-Wave controller is required.

5.1 INSERT BATTERIES

Remove the battery cover (Fig.1).

Now insert the batteries. Pay attention to the correct polarity! Do not use rechargeable batteries!

Reattach the battery cover to the Comet Z-Wave (Fig.2) by pressing it on until it clicks.

In case of a later battery change, the configuration of your Comet Z-Wave will be preserved.

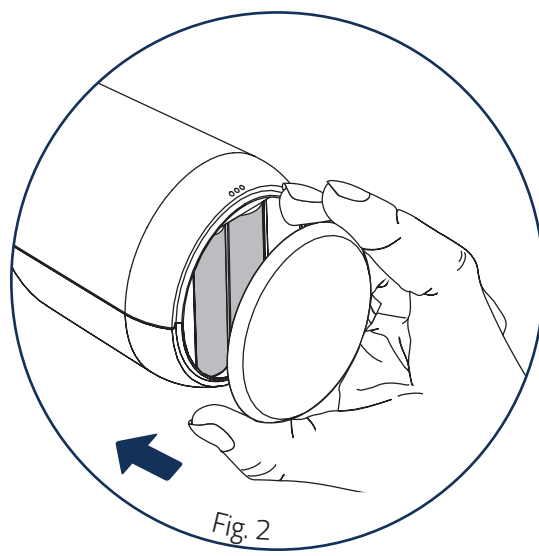
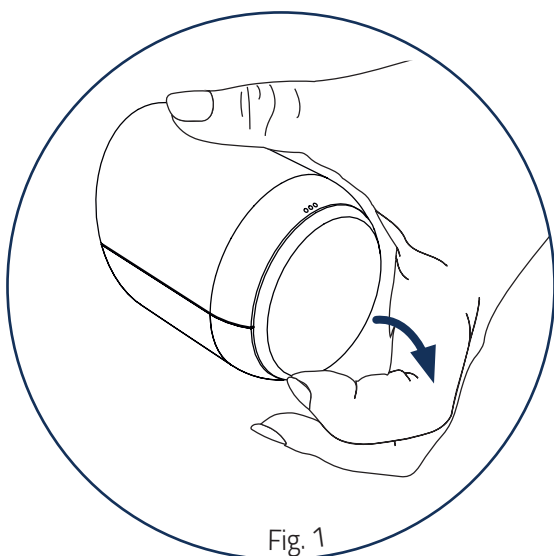

5.2 SET UP INTO A Z-WAVE NETWORK

Put your primary Z-Wave controller into include mode.
 If Comet Z-Wave was successfully added, the LED display will show the received node ID.

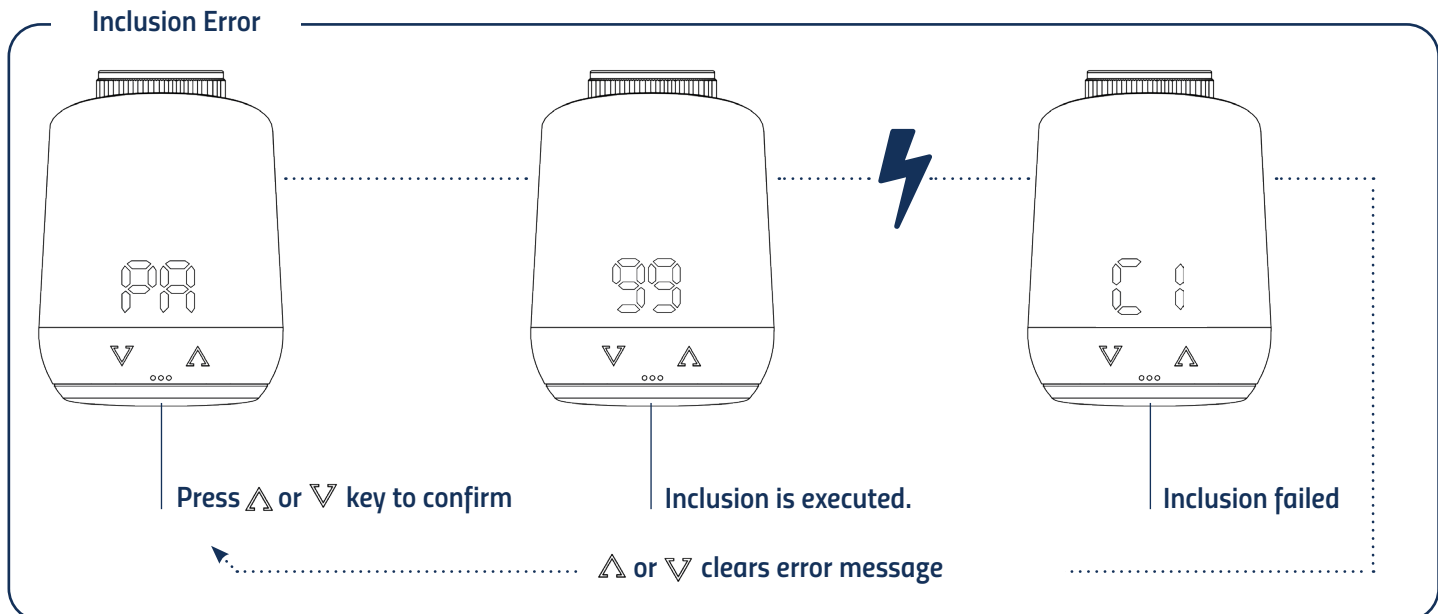
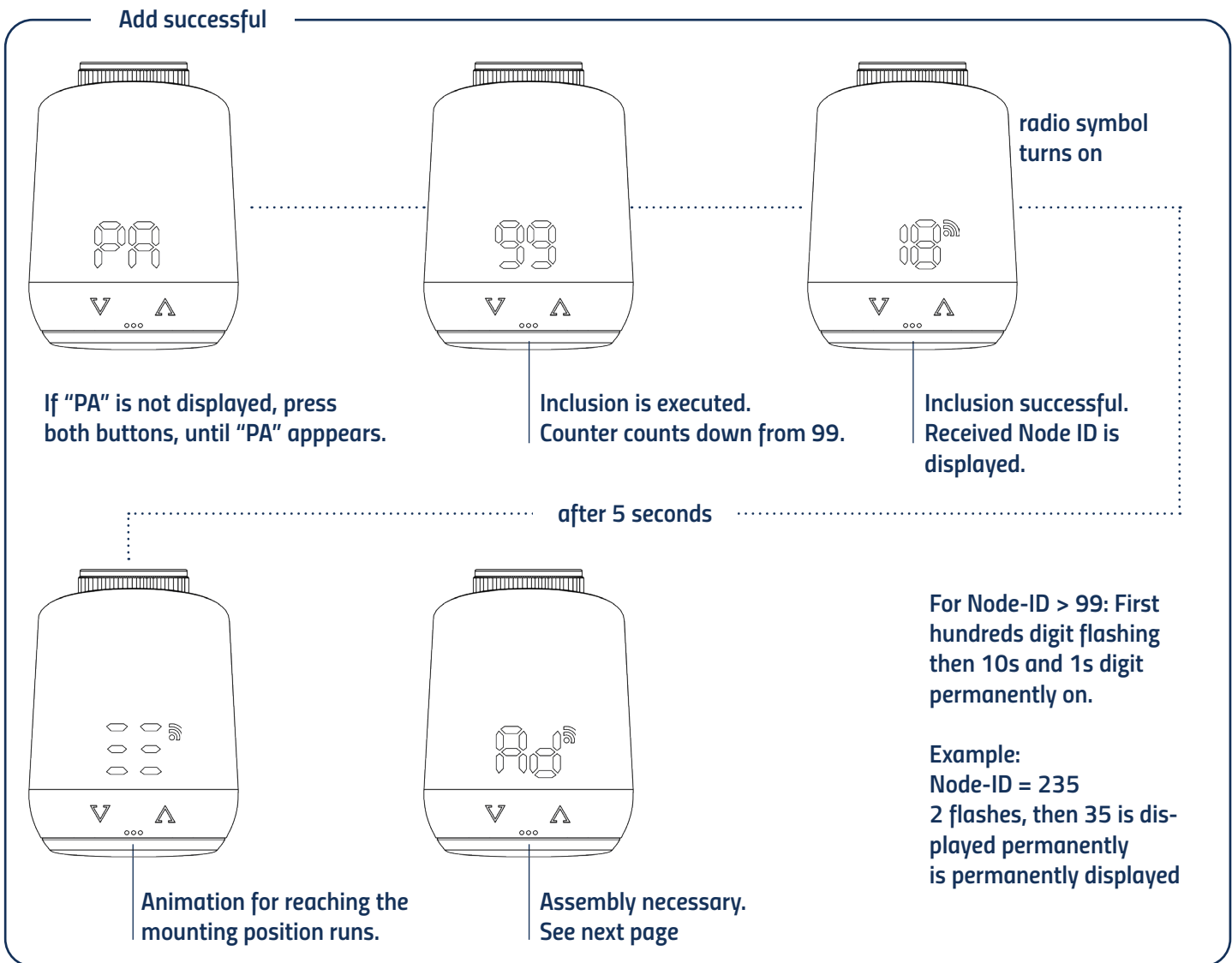

5.3 MOUNTING AT A RADIATOR

After adding (inclusion), the LED display shows an animation and the thermostat moves to the mounting position. Subsequently, the LED display shows "Ad".

Follow the mounting steps below:

1. Unscrew old thermostatic head completely, loosen fastening and pull it off the valve (fig.3).
2. If necessary, select a suitable adapter and mount it on the valve (Fig.4).
3. Screw the thermostat onto the valve or adapter by turning the union nut clockwise (Fig.5).

When you have mounted the Comet Z-Wave on the valve, continue with 5.5 Adaptation.

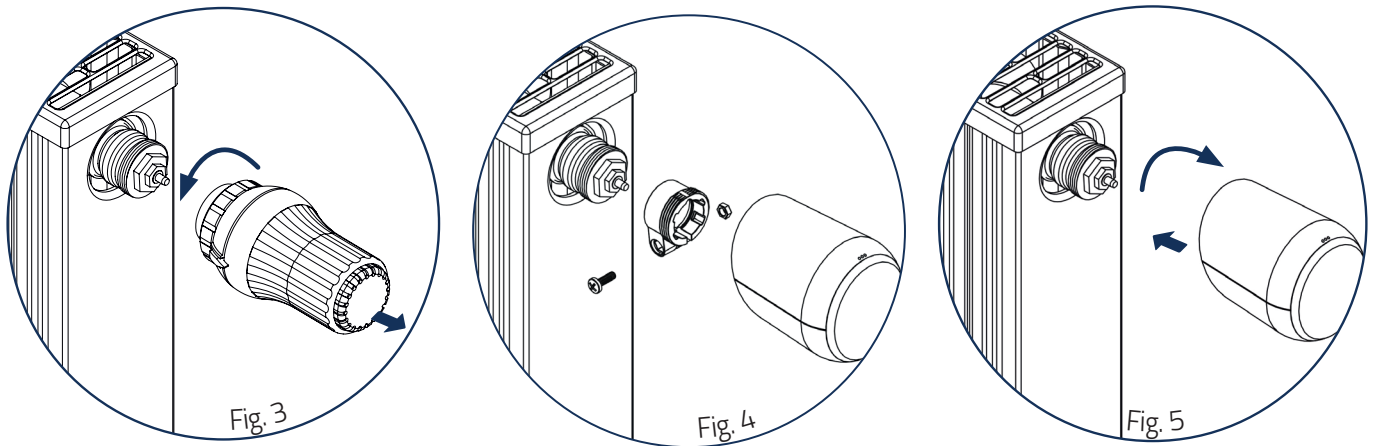

5.4. ADAPTER

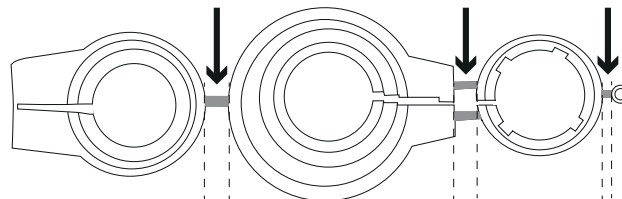

Fig. 6

NOTE:

Remove the connecting pieces of the plastic adapters completely (Fig.6) before using one of the enclosed adapters! For Danfoss RA/RAV use the enclosed screw and nut.

No adapter is required for the following valves:

Heimeier; Junkers Landys+Gyr; MNG; Honeywell; Braukmann, as these have a thread dimension of M30 x 1.5 mm. The adapters for Danfoss RAV (pin must be plugged on valve tappet), Danfoss RA and Danfoss RAVL are enclosed.

You will need an adapter for the following valves:

Herz M28 x 1,5 mm; Comap M28 x 1,5 mm; Vaillant 30,5 mm; Oventrop M30 x 1,0 mm; Meges M38 x 1,5 mm; Ondal M38 x 1,5 mm; Giacomini 22,6 mm; Rossweiner M33 x 2,0 mm; Markaryd M28 x 1,0 mm; Ista M32 x 1,0 mm; Vama M28 x 1,0 mm; Pettinaroli M28 x 1,5 mm; T+A M28 x 1,5 mm; Gampper 1/2/6; Danfoss RA/RAV/RAVL.

You can purchase further metal adapters for a fee from our partners. An overview of the metal adapters and corresponding ordering options can be found under the following link:
<https://eurotronic.org/produkte/zubehoer/metalladapter/>

If you are not sure which valve you have, see: <https://eurotronic.org/service/faq> In chapter „Adapterliste“.

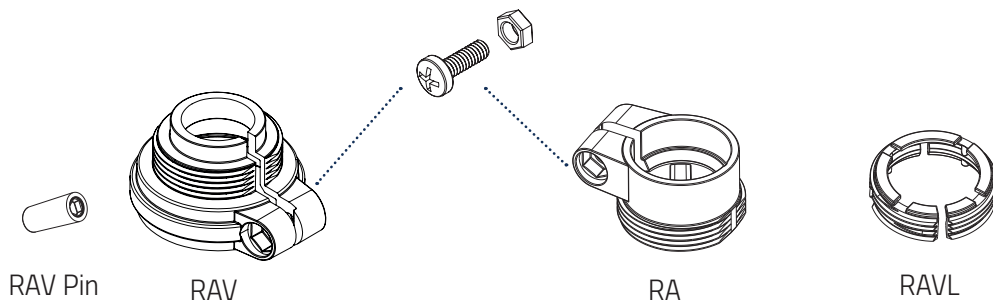

5.5 ADAPTATION

Adaptation

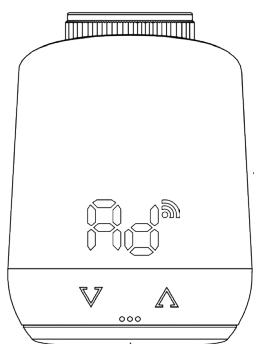

Press and hold \triangle and ∇ key together for 3 seconds, to start adaptation.

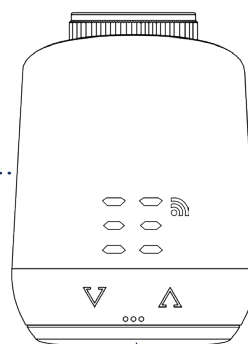

Adaptation is executed.
Animation is displayed.

Adaptation successful

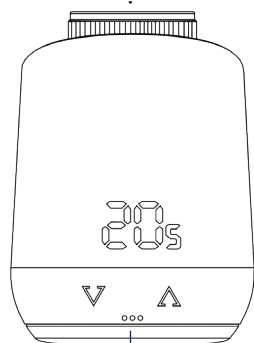

Target temperature of 21° is displayed.

NOTE:

If a new adaptation is required later, remove the batteries from the device and reinsert the batteries. "Ad" then appears on the LED display. Now start the adaptation by simultaneously holding down both keys \triangle and ∇ for 3 seconds.

Adaptation error

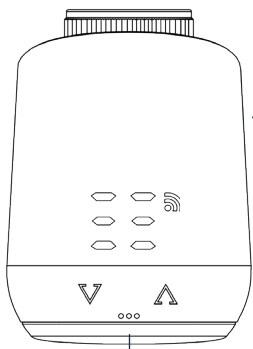

Mounting position is prepared.
Animation is displayed.

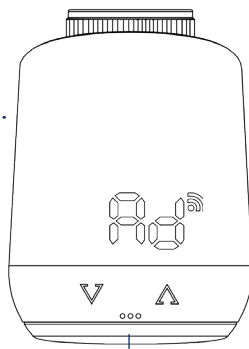

Press and hold Δ and ∇ key
together for 3 seconds.

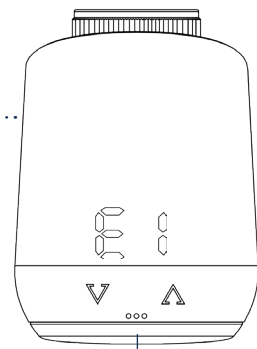

Adaptation failed.
Repeat the process.



Δ or ∇ key clears error message.

5.6 DELETE A DEVICE OUT OF A Z-WAVE NETWORK

Please put your Z-Wave controller into the exclusion mode. Then press and hold the button in the battery compartment for 5 seconds until "LE" appears in the display.

Exclusion

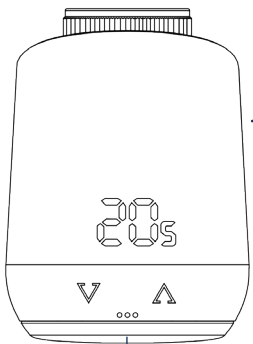

Press key in battery compartment for 5 seconds.

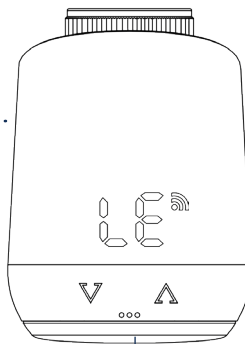

Radio symbol flashes during exclusion mode.

Exclusion is executed.
Countdown starts from 99 to 0

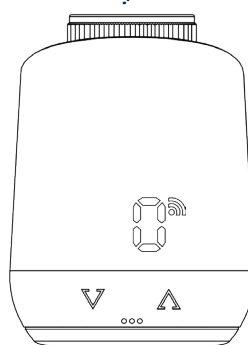

Exclusion successful

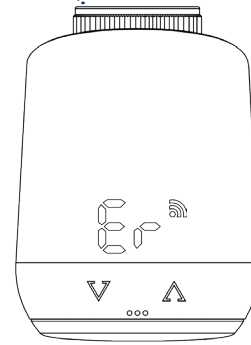

Exclusion failed

5.7 DISMOUNTING COMET Z-WAVE

Remove the Comet Z-Wave from the network before disassembling the device. To do this, please put your Z-Wave controller in the removal mode (Exclusion). Then press and hold the button in the battery compartment for 5 seconds (Fig.7). The LED display shows Node ID 0 if the removal was successful and the valve tappet moves into mounting position. Wait until the display shows "PA". Now unscrew the union nut counterclockwise and remove it from the Comet Z-Wave valve (Fig.8).

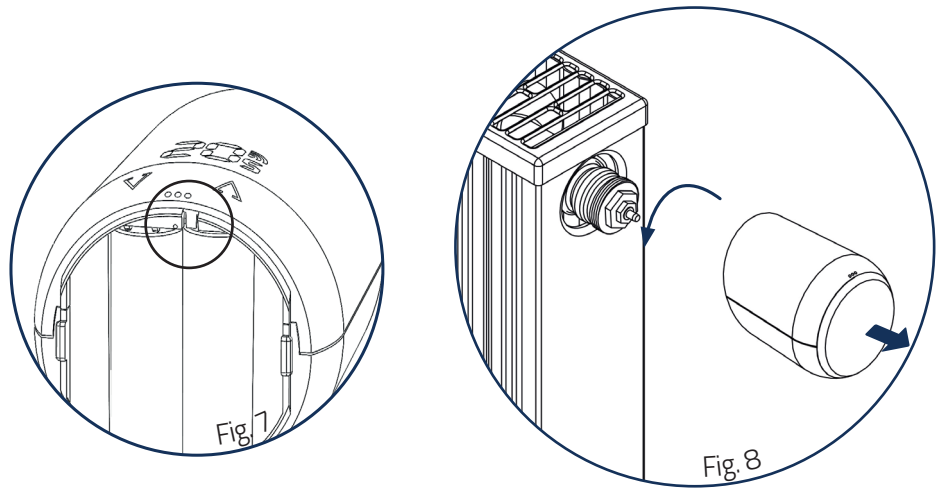

5.8 FACTORY RESET

Press and hold the button in the battery compartment of your Comet Z-Wave for at least 10 seconds. From the 5th second on, a counter will run on the thermostat's display. Keep the button pressed until the 10 appears on your Comet Z-Wave. Then "PA" will be shown again on the display and the controller will be in teach-in mode.

NOTE: Use the factory reset only if your primary Z-Wave controller is no longer available or is inoperable for other reasons.

Counter counts up from 5 to 10. After reaching 10, the display shows "PA" again.
The pairing mode is active again.



6 OPERATING THE DEVICE

The LED display shows the set setpoint temperature or the set valve opening degree when the Comet Z-Wave is operated in the actuator mode.

6.1 SETTING THE TARGET TEMPERATURE

The set temperature is changed via the and button.

The local change of the setpoint temperature puts the Comet Z-Wave in heating mode.

The setpoint temperature of the setback mode can only be adjusted by radio.

The input range of the set temperature is 8° - 28°C.

If the temperature is increased or decreased beyond this, the Comet Z-Wave will switch to boost or off mode.

6.2 CHILD PROTECTION / KEY LOCK

The child lock can be switched on and also switched off again by simultaneously holding down the ▲ and ▼ button for 3 seconds, when the display is off.

If the Comet Z-Wave is set to the highest protection level by radio, local operation is no longer possible. The child safety lock can then also no longer be removed locally.

6.3 CHANGING THE OPERATING MODE

OFF-Mode

Press the ▼ key as long as „--“ is displayed on your thermostat.

Heating-Mode

If the device is not in the heating-mode, change the temperature by using keys, between 8 to 28 degrees.

Boost-Mode

If your device is not in the Boost-mode, keep the ▲ key pressed, until the device displays “ON”

6.4 WINDOW OPEN DETECTION

If the temperature drops abruptly, the window open mode is activated. The Comet Z-Wave will switch to off mode for 10 minutes. The window-open mode is automatically exited after 10 minutes and the previously active mode is restored.

In Manufacturer Specific Mode, the window-open detection is not executed.

The sensitivity of the window open detection can be configured.

6.5 DISPLAY NODE ID

You can display the network ID of the Comet Z-Wave. To do this, press and hold the button in the battery compartment for 3 seconds.

7 OPERATING Z-WAVE

Command category	Description	Version	Control (C) Support (S)	Security *
Association	Creates assignments between Z-Wave devices.	2	S	U, S0, S2
Association Group Information	Enables the grouping of assignments.	3	S	U, S0, S2
Basic	Enables the setting of basic functions.	2	S	U, S0, S2
Battery	Informs about the battery status.	1	S	U, S0, S2
Configuration	Allows to configure the Comet Z-Wave.	1	S	U, S0, S2
Device Reset Locally	Alerts the central unit that the Comet Z-Wave has been reset locally.	1	S	U, S0, S2
Manufacturer Specific	Provides information about manufacturer and product identifier	2	S	U, S0, S2
Multilevel Sensor	Provides the actual temperature of the Comet Z-Wave.	11	S	U, S0, S2
Multilevel Switch	Supplies or sets the valve opening degree of the Comet Z-Wave. The control of the valve opening degree is only possible in the Manufacturer Specific Mode.	1	S	U, S0, S2
Notification	Sends notifications e.g. in case of system errors.	8	S	U, S0, S2
Power Level	Configures the transmit power during installation or test cases.	1	S	U, S0, S2
Protection	Protects the device from local adjustment (child lock).	1	S	U, S0, S2
Security	Sets the Comet Z-Wave operating mode.	1	S	U
Thermostat Mode	Sets the target temperature of the Comet Z-Wave.	3	S	U, S0, S2
Thermostat Setpoint	Enables encrypted data traffic.	3	S	U, S0, S2
Transport Service	Enables the transmission of particularly large radio telegrams.	2	S	U
Version	Gives information about the Z-Wave protocol version.	3	S	U, S0, S2
Z-Wave Plus Info	Allows to distinguish between Z-Wave Plus and Z-Wave devices.	2	S	U

* Command categories availability after adding the Comet Z-Wave.

U Unencrypted

S0 Z-Wave security standard S0

S2 Z-Wave security standard S2

7.1 ASSOCIATION

Comet Z-Wave can be connected only with the Z-Wave controller.

Group No.	Description	Commands	Max. Links
1	(Lifeline)	BATTERY_REPORT, DEVICE_RESET_LOCALLY_NOTIFICATION, THERMOSTAT_MODE_REPORT, THERMOSTAT_SETPOINT_REPORT, NOTIFICATION_REPORT, PROTECTION_REPORT, SENSOR_MULTILEVEL_REPORT, SWITCH_MULTILEVEL_REPORT	1

7.2 BASIC

Using the Basic command class, you can change the operating mode if your Z-Wave controller does not fully support Comet Z-Wave.

Value	Designation	Function
0x00	Energy Save Heating	Control according to set setback temperature
0x0F	OFF	Radiator off. Hold 7.5°C
0xFE	Manufacturer Specific	Switching to the actuating value mode
0xFF	Heating	Rules according the comfort temperature setup

7.3 CONFIGURATION

Comet Z-Wave can be configured during runtime.

Parameter Number	Size in Bytes	Name	Description
1	1	LCD invert	0x00 LCD content normal 0x01 LCD mirrored content default: 0x00
2	1	LCD Timeout	0x05-0x1E Timeout after 5 seconds - 30 seconds default: 0x05
4	1	Batteriestatus	0x00 Batteriestatus Send only event-controlled as system warning 0x01 Batteriestatus send 1x a day default: 0x00
5	1	Actual-Temperature	0x00 Send Actual-Temperature not automatically 0x05-0x32 With temperature difference of 0.5°C - 5.0°C transfer actual temperature default: 0x05 (When Delta = 0,5°C report)
7	1	Window-open-detection	0x00 Deactivated 0x01 low sensitivity 0x02 medium sensitivity 0x03 high sensitivity default: 0x01 low sensitive
8	1	Actual-Temperature-Offset	0xCE-0x32 -5,0°C - (+) 5,0°C default: 0x00 0,0°C Offset

7.4 MULTILEVEL SENSOR

The room temperature measured by the Comet Z-Wave is automatically sent at a change of $\pm 0.5^{\circ}\text{C}$. The threshold value can be configured.

Report outgoing

Sensor type: „Air Temperature“
Scale: Celsius
Tolerance:

The room temperature measured by Comet Z-Wave can be adjusted via an offset.

7.5 MULTILEVEL SWITCH

The current opening degree of the valve can be queried via radio. Alternatively, a threshold value can be set to automatically report the valve opening degree to the Z-Wave controller. However this depends on the range of individual valve stroke.

NOTE: Control of the valve opening degree is only possible when the device is in actuator mode.

7.6 NOTIFICATION

The Comet Z-Wave sends event-dependent notifications to the Z-Wave controller.

Notification type	Reason	Description
Power Management	Replace battery soon	25% Battery charge remaining
Power Management	Replace battery now	15% Battery charge remaining Replace batteries now
System	System Hardware failure with manufacturer proprietary failure code	Mechanical error: 0x01 No closing point found 0x02 No valve movement possible 0x03 No valve closing point detected 0x04 Positioning failed

7.7 CHILD PROTECTION / KEY LOCK

The child lock/key lock of the Comet Z-Wave can be set or removed by radio.

Protection status	Description
0x00	Unprotected - Operation possible without restrictions
0x01	Limited - Operation not possible. Device must first be unlocked
0x02	Deactivated - Operation completely disabled. Device can only be controlled by radio.

7.8 THERMOSTAT MODE

The Comet Z-Wave can be set to the following operating modes.







Mode	Name	Description
0x00	Off	Off-Mode: The Comet Z-Wave does not heat and tracks only 6°C as a frost protection measure
0x01	Heat	Comfort mode: The Comet Z-Wave heats the room to the set comfort temperature
0x0B	Energy Heat	Setback mode: The Comet Z-Wave heats the room to the set setback temperature.
0x1F	Manufacturer Specific	Setpoint mode: The Comet Z-Wave switches to actuator mode and allows controlling the valve opening degree via the Multilevel Switch command class.

7.9 THERMOSTAT SETPOINT

Allows configuring the setpoint temperatures for HEAT and ENERGY HEAT modes.
It is not possible to change the set temperatures for OFF and FULL POWER HEATING modes.

Mode	Name	Tolerance	Scale	Temperature range
0x01	Heat		Celsius and Fahrenheit	8°C - 28°C
0x0B	Energy Heat		Celsius and Fahrenheit	8°C - 28°C

8 ERRORS AND MESSAGES HELP

Problem	Reason	Solution
	Batteries almost empty	Replace batteries
Radiator does not warm up.	Boiler water temperature O.K? Valve does not open after summer Heating break calcified?	Correct the boiler water temperature. Disassemble the Comet Z-Wave. Move the valve tappet back and forth several times by hand/tool.
Radiator does not cool down.	Valve does not close completely. Possibly the closing point of your valve seal has shifted.	Dismount the Comet Z-Wave. Move the valve tappet several times by hand - adaptation may not be possible because your valve may be calcified or the seal no longer fulfills its function.
Pressure piece falls out	Due to an endless thread, the thrust piece sitting on the underside can fall out if the regulator has not been applied to the valve.	Remove the batteries from the device. Insert the pressure piece. Insert batteries.
C1, Er, Er 1 - 3	The displayed errors can be cleared by pressing the ▲ or ▼ key.	
	Inclusion failed	Z-Wave controller not in inclusion mode or out of range.
	Exclusion failed	Z-Wave controller not in Exclusion mode or out of range.
	No valve movement possible	Valve tappet freely movable?
	No valve detected	Mount the device correctly on the radiator. Use correct adapter.
	Closing point not detected	Device correctly mounted on the radiator?

9. CLEANING AND STORAGE

NOTE RISK OF DAMAGE!

Improper handling of the thermostat may cause damage.

- Do not immerse the thermostat in water or other liquids.
- Do not use aggressive cleaning agents, brushes with metal or nylon bristles or sharp or metal cleaning objects such as knives, hard spatulas and the like.
- sharp or metallic cleaning objects such as knives, hard spatulas and the like.
- These can damage the surfaces.
- Clean the thermostat with a soft, dry cloth.

Switch off the device and remove the batteries if you do not use the device for a longer period of time. Store the device in a dry, dust-free place.

10. TECHNICAL SPECIFICATION

Device name	Comet Z-Wave	Method of operation	Type 1
EAN	4260012712421	Dimension (mm)	(B x H x T): 62x68x83
Article number	700226	Weight	230g (incl. batteries)
Power supply	2 x 1,5V LR6/Mignon/AA	Degree of protection	IP20
Radio frequency	868,42 MHz	Degree of pollution	2
Transmitting power	+4 dBm	Connection	M30 x 1,5mm

Subject to technical changes at any time. Compatibility information without guarantee.

11. SUPPORT AND CONTACT

For technical support please contact us by email or phone.

Eurotronic Technology GmbH

Südweg 1
36396 Steinau - Ulmbach
Germany

Telefon: +49 (0) 6667 91847-0
Email: support@eurotronic.org
Internet: www.eurotronic.org

12. WARRANTY

The warranty period is 24 months and starts on the day of purchase. Please keep the receipt as proof of purchase. During the warranty period, defective energy-saving controllers can be sent to the service address below with sufficient postage. You will then receive a new or repaired device back free of charge. Repair or replacement of the device does not start a new warranty period. Please note that we only guarantee the functions of the device, not the functionality between the interaction of the thermostat and the valve base.

The application-related technical data are guaranteed only together with the valves Heimeier, Junkers Landys+Gyr, MNG, Honeywell Braukmann thread dimension (M30x1,5), Oventrop (M30x1,5) Danfoss RA, RAV and RAVL. The device combinations can be taken from our website (<https://eurotronic.org/service/faq>). When operating the thermostat with third-party valves/adapters that are not listed, the functionality must be ensured by the user. Eurotronic does not provide any warranty service in these cases. After the warranty period has expired, you also have the option of sending the defective device, with sufficient postage, to the address provided for the purpose of repair. Repairs carried out after the expiry of the warranty period are subject to a charge. Your statutory rights are not restricted by this warranty.

13. LEGAL INFORMATION

Dispose of thermostat:

(Applicable in the European Union and other European countries with systems for separate collection of recyclable materials). Old devices must not be disposed of with household waste! If the thermostat can no longer be used, every consumer is required by law to dispose of old devices separately from household waste, e.g. at a collection point in his community/borough. This ensures that old appliances are recycled properly and that negative effects on the environment are avoided. This is why electrical appliances are marked with the symbol shown here.

Batteries and rechargeable batteries must not be disposed of in household waste!



As a consumer, you are required by law to take all batteries and rechargeable batteries, whether they contain harmful substances* or not, to a collection point in your municipality/borough or to a retailer so that they can be disposed of in an environmentally friendly manner.

Dispose of packaging:



Dispose of the packaging according to type. Put cardboard and carton in the waste paper collection, foils in the recyclables collection.

Konformitätserklärung:



Eurotronic Technology GmbH hereby declares that the Comet Z-Wave radiator thermostat is in compliance with Directive 2014/53/EU. The full text of the EU Declaration of Conformity is available at the following internet address: <https://eurotronic.org/produkte/z-wave-heizkoerperthermostat>.

*marked with: Cd = Cadmium, Hg = Mercury, Pb = Lead