

# SPIRIT ZigBee<sup>®</sup>

Installation & Operation Guide



# Contents

---

1	Scope of Delivery	3	6.2	Identify	14
2	Warning Instructions	4	6.3	Power configuration	14
3	This is Spirit ZigBee	5	6.4	Time	15
4	Operating and Display Elements	5	6.5	Thermostat	15
4.1	Buttons	5	6.5.1	Application Version Attribute	16
4.2	Boost button LEDs	6	6.5.2	PI Heating Demand Attribute	16
4.3	LCD	6	6.5.3	Errors	16
	Commissioning	7	6.5.4	Current Temperature Setpoint	16
	Inserting the batteries	7	6.6	Attribute Reporting	17
4.4	Joining a ZigBee network	8	7	Troubleshooting and Error Messages	18
4.5	Mounting on the radiator	9	8	Cleaning	18
4.6	Adapting	10	9	Adapter	19
4.7	Removing the Spirit ZigBee	11	10	Technical Data	19
4.8	Restoring the factory settings	11	11	Support and Contact	19
5	Local Operation	12	12	Warranty Information	20
5.1	Setting the target temperature	12			
5.2	Activating the child safety lock	12			
5.3	Changing the operating mode	12			
5.4	Window open detection	13			
6	ZigBee Operation	13			
6.1	Basic	14			

# 1 Scope of Delivery

1. **Spirit ZigBee** Energy-saving thermostat
2. **Screw**
3. **Adapter for Danfoss valves (RA / RAV / RAVL)**
4. **2x AA batteries**

\* If you use a RAV adapter, you need to extend the valve stem with a RAV pin.

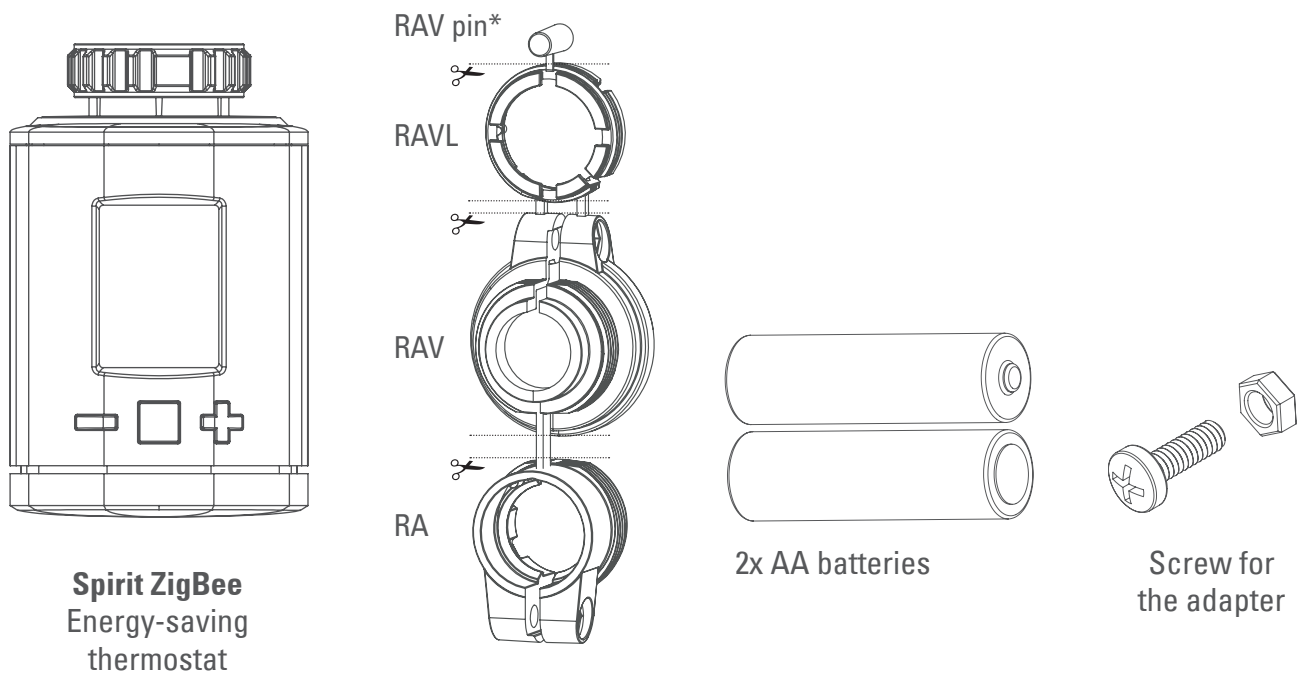

## 2 Warning Instructions

---

### **WARNING!**

This signal word designates a risk with an average degree of risk that can cause death or severe injury if it is not avoided.

**INFORMATION!** This signal word warns you against possible property damage.

### **SAFETY INFORMATION**

- The Spirit ZigBee is designed for use in buildings.
- Only use the Spirit ZigBee as described in the operation guide.
- The Spirit ZigBee is only to be used in a dry and dust-free place and not be subjected to direct sunlight.
- Do not continue to use the device should it show obvious signs of damage.
- The Spirit ZigBee is not to be converted, modified or opened.

### **WARNING! RISK OF EXPLOSION!**

An incorrect handling of batteries can result in an explosion.

- Do not heat the batteries up and do not throw them into an open fire.
- Do not place batteries in direct sunlight.
- Protect batteries from strong heat.
- Do not short-circuit the batteries.
- Never attempt to charge non-chargeable batteries.
- Never take batteries apart.
- Never use new and used batteries at the same time.
- Observe the correct polarity when inserting the batteries (+/-).
- Clean the batteries and the contacts in the thermostat before inserting the batteries.

### **WARNING! RISK OF CHEMICAL BURNS!**

Leaking battery acid can cause chemical burns.

- Prevent battery acid from coming into contact with the skin, eyes and mucous membranes
- Should you come into contact with battery acid, immediately rinse the affected area with copious amounts of clear water and consult a doctor.

### **WARNING! RISK OF INJURY!**

Keep the thermostat and the packaging away from small children as they could swallow small parts and choke on them.

- Do not let children play with the thermostat or the packaging.
- Keep the batteries out of reach of children. Consult a doctor without delay should batteries be swallowed.

# 3 This is Spirit ZigBee

Spirit ZigBee is an energy-saving thermostat for the heating radiator that is compatible with the ZigBee wireless standard.

**As a heating radiator thermostat, the Spirit ZigBee uses the Home Automation Profile 1.2 as an HVAC compatible terminal device.**

# 4 Operating and Display Elements

## 4.1 Buttons

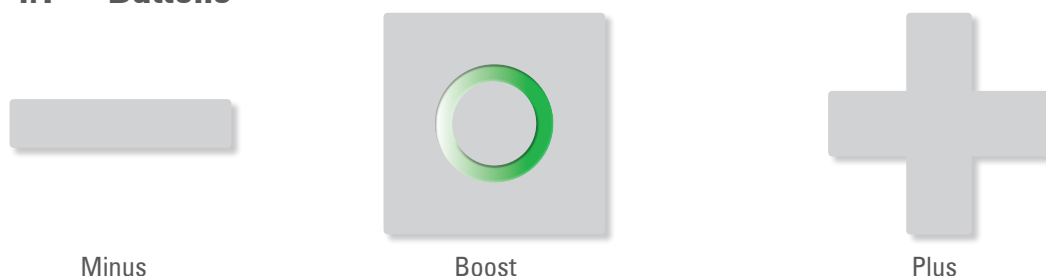

Button	Status	Meaning
	press once	Reduce the target temperature by 0.5°.
	press and keep pressed in	Immediately reduce the target temperature by 0.5°C, then reduce it by 0.5°C every 0.5 seconds as long as the button remains pressed in or the end value is reached.
	press once	Increase the target temperature by 0.5°.
	press and keep pressed in	Immediately increase the target temperature by 0.5°C, then increase it by 0.5°C every 0.5 seconds as long as the button remains pressed in or the end value is reached.
	press once	<ul style="list-style-type: none"><li>• Execute the displayed function</li><li>• Switch to boost mode.</li><li>• Terminate boost mode if in boost mode.</li></ul>
	keep pressed for 10 seconds	The duration during which the buttons are pressed is displayed. Release after 10 seconds; the device enables a works reset to be carried out.
	keep pressed together for 3 seconds	Activate or deactivate the child safety lock.





## 4.2 Boost button LEDs



Boost – green





Boost – red

Colour	Status	Meaning
	flashing	Over the Air update of the controller software is being carried out. A controlling of the temperature is not possible.
	permanently illuminated	Error when taking into operation.
	flashing	The user is to provide confirmation. Is used in order to start processes.
	illuminated for 5 seconds	A process has been successfully completed.

## 4.3 LCD

 **Spanner:**  
Provides information on mechanical processes.

 **Radio antenna:**  
Provides information on the radio connection and add-in procedures.  
Is activated if there is a radio connection.  
Deletes if there is no longer a radio connection.

 **Battery:** illuminated if the battery power is below 15%.

 **Padlock:** illuminated if the child safety lock has been activated.

**°C Degrees Celsius:** illuminated permanently in combination with the target temperatures.

**% Percent symbol:** illuminated permanently in combination with setpoints.

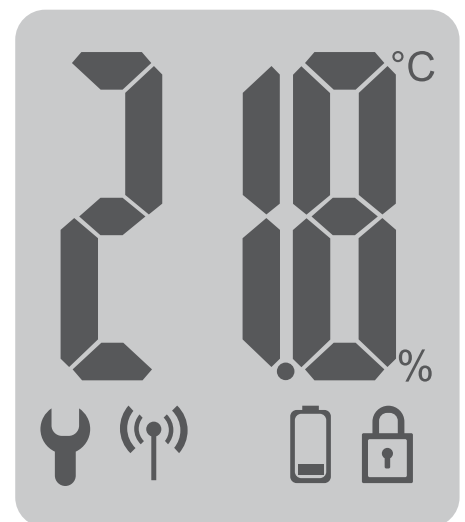

# Commissioning

---

The Spirit ZigBee is not installed in a ZigBee network ex works. The Spirit ZigBee is to be added to an existing network before it can communicate with other ZigBee devices. This procedure is referred to as joining.

The Spirit ZigBee can also be removed from a network again. This procedure is referred to as leaving.

Both of these procedures are to be initiated by a primary ZigBee controller. This necessitates the controller being placed in a joining or leaving mode. Instructions on how you can start the modi are provided in the Operating Guide for your ZigBee controllers.

ZigBee devices can only join or leave the network if the primary controller is in the join/leave mode.

Should the device already be connected to a network, it initially has to leave this network or the joining attempt shall otherwise be unsuccessful.

## Behaviour in the ZigBee network

The Spirit ZigBee can join any of the ZigBee networks, it then being able to be operated together with other ZigBee-certified devices and/or applications from other manufacturers.

All non-battery operated network nodes act as a repeater within the network, regardless of the manufacturer, an improve the reliability of the radio network.

## Network security

Spirit ZigBee can communicate with other ZigBee devices in an encrypted form as long as this also supports an encrypted communication.

# Inserting the Batteries

---

Remove the cover of the battery compartment by pushing it upwards at the marked point and hanging it out. Now insert the batteries. Ensure that the polarity is correct! The configuration of your Spirit ZigBee is retained should you replace the batteries later.

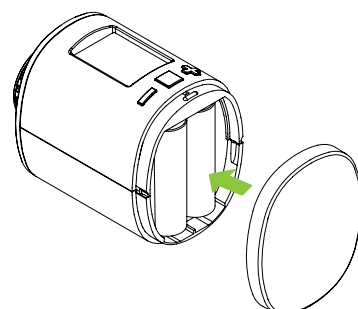
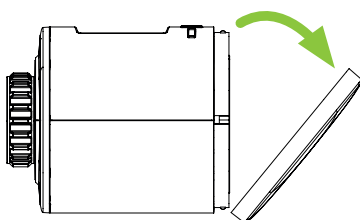

## 4.4 Joining a ZigBee network

After the batteries have been inserted, PrP is displayed and the Spirit ZigBee prepares itself for the installation. The Spirit ZigBee is set in join mode at factory, this being indicated by a flashing radio symbol on the LCD display.

If the Spirit ZigBee has successfully joined, the LCD display permanently displays the radio symbol and the LED flashes green.

Commissioning process will continued by pressing Boost button.

The installation can be carried out when the LCD displays "INS". Please continue with "4.5 Mounting on the Heating Radiator" fort.

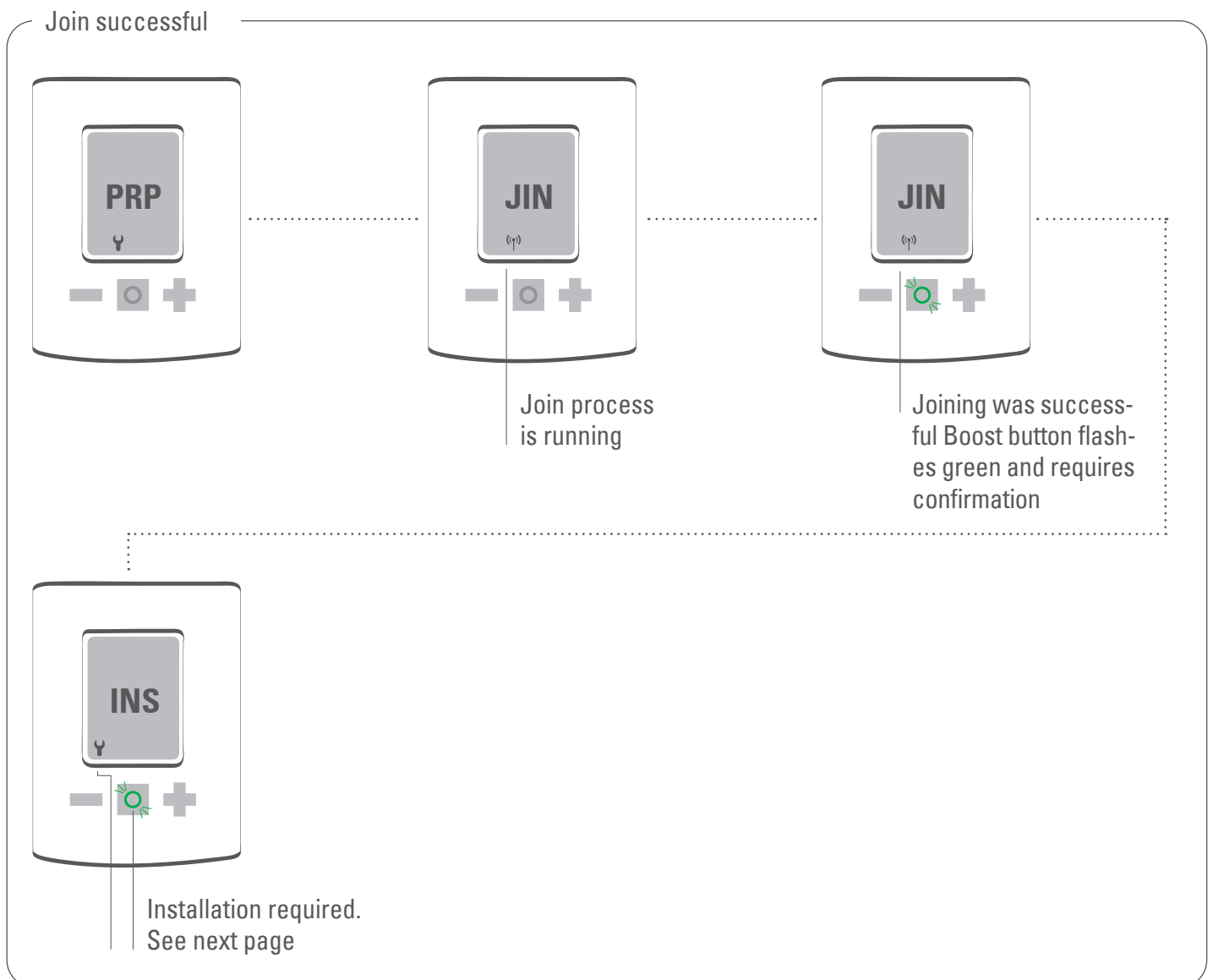



### Joining error

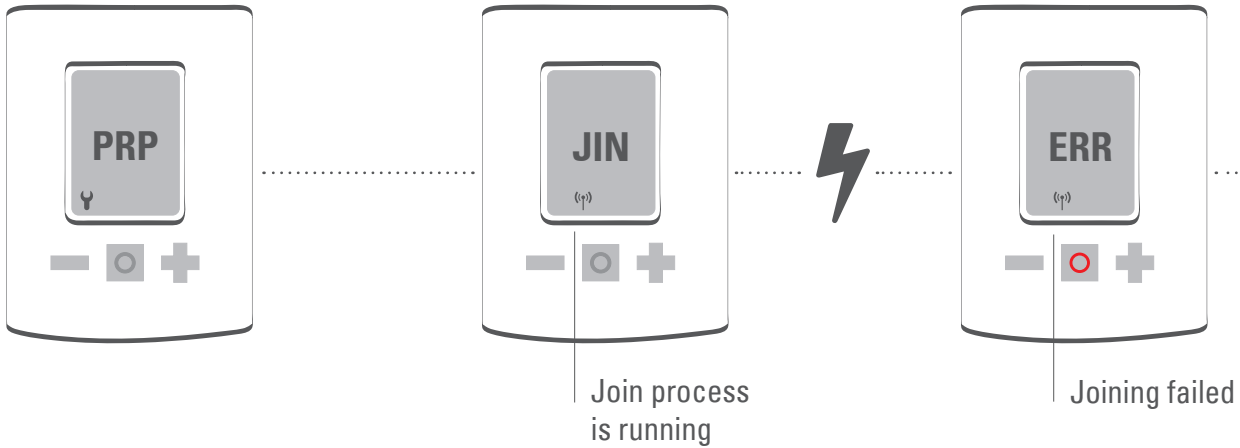

## 4.5 Mounting on the radiator

After the joining has been completed, "INS" is displayed on the LCD and the Boost button flashes green. Do not confirm the button yet. Follow the mounting steps. After you have mounted the Spirit ZigBee on the valve, continue with 4.6 Adapting.

### Mounting without an adapter

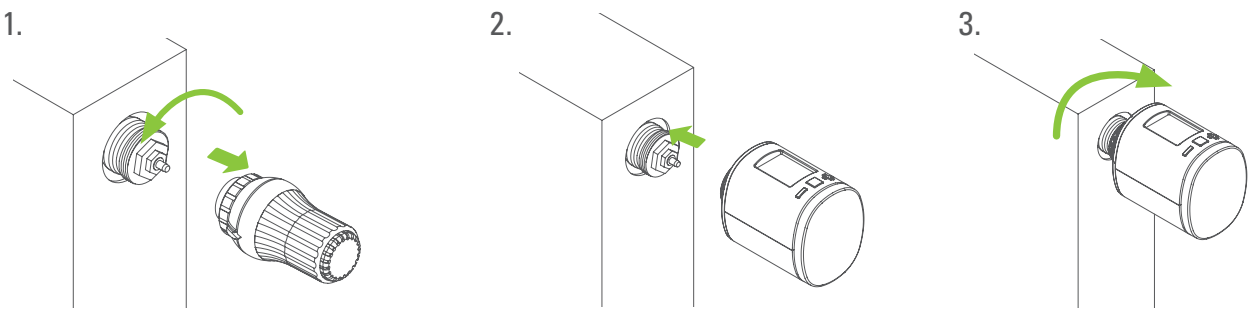

### Mounting with an adapter

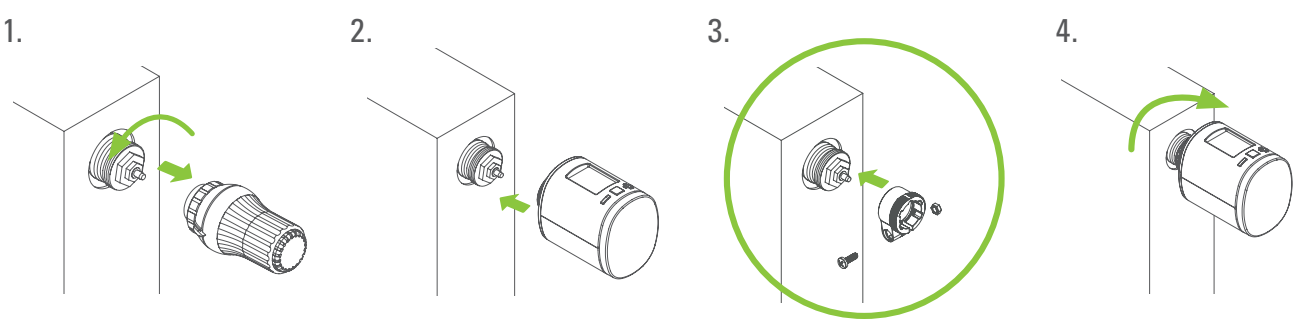

## 4.6 Adapting

Confirm the Boost button in order to start the adapting.

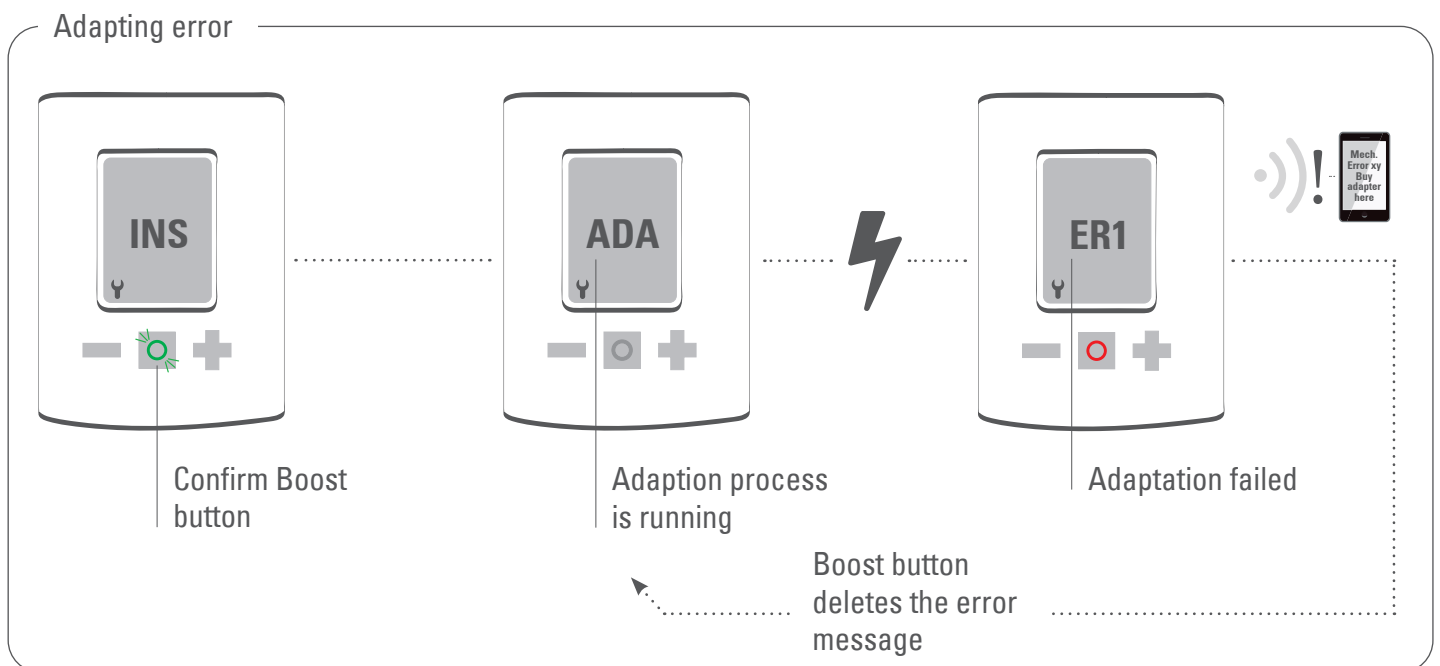
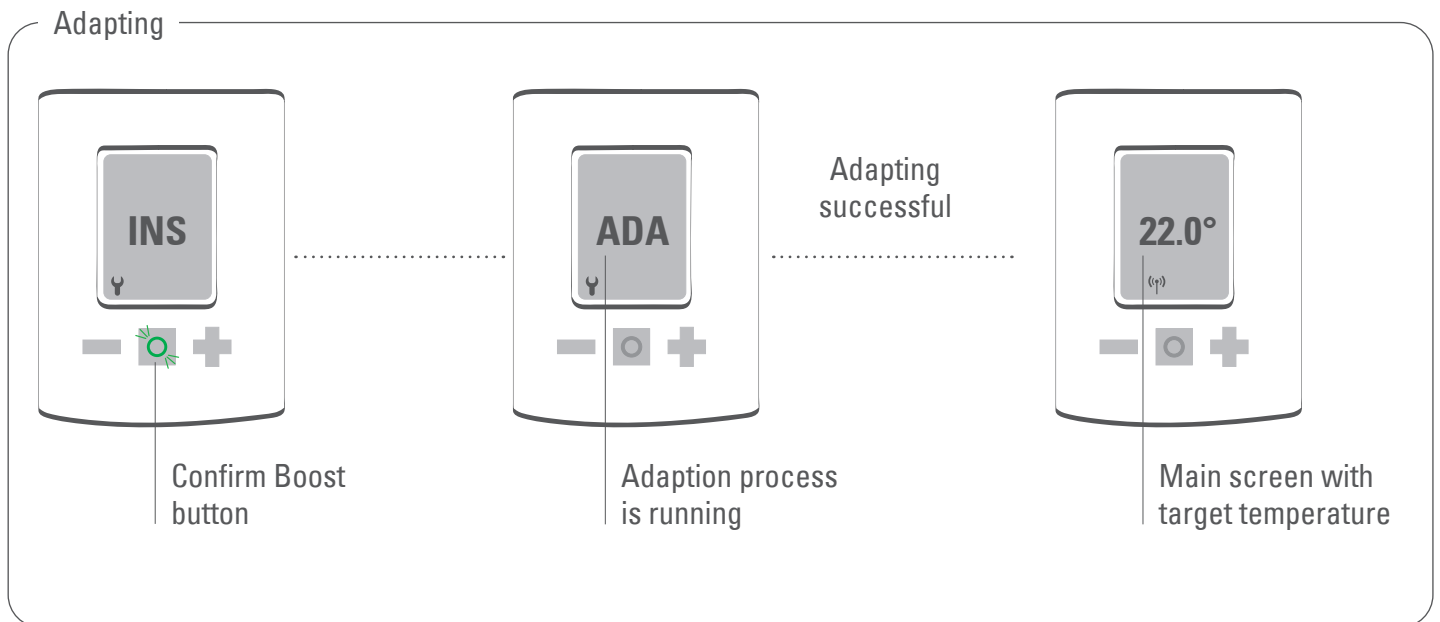

## 4.7 Removing the Spirit ZigBee

Disconnect the Spirit ZigBee from the network before you remove the device. To do so, set your ZigBee controller to the leave mode. The Spirit ZigBee should display "RES" and the valve stem moves to the mounting position. Should a Spirit ZigBee will not leave automatically, manually remove it from ZigBee network (see 4.9 restoring the factory settings).

Now unscrew the union nut and remove the Spirit ZigBee from the valve.

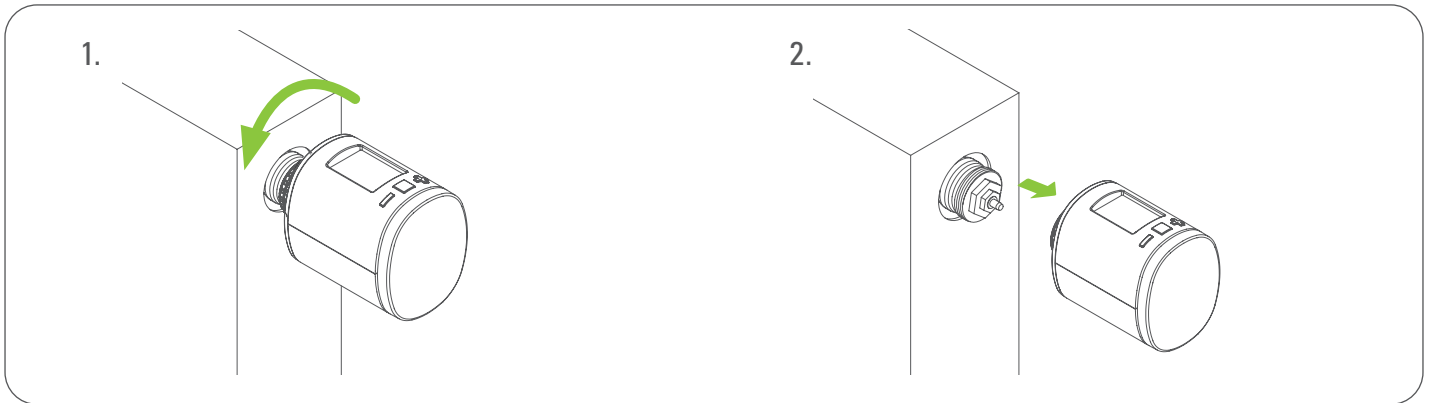

## 4.8 Restoring the factory settings

Press the Boost, Plus and Minus button until the counter in the LCD has reached 10.

Only release the button when the LCD displays "RES".

The reset will start shortly after the button has been released.

The LCD displays "PrP" and the valve stem moves to the mounting position.

Only use the factory reset if your primary ZigBee controller no longer exists or does not function for other reasons.

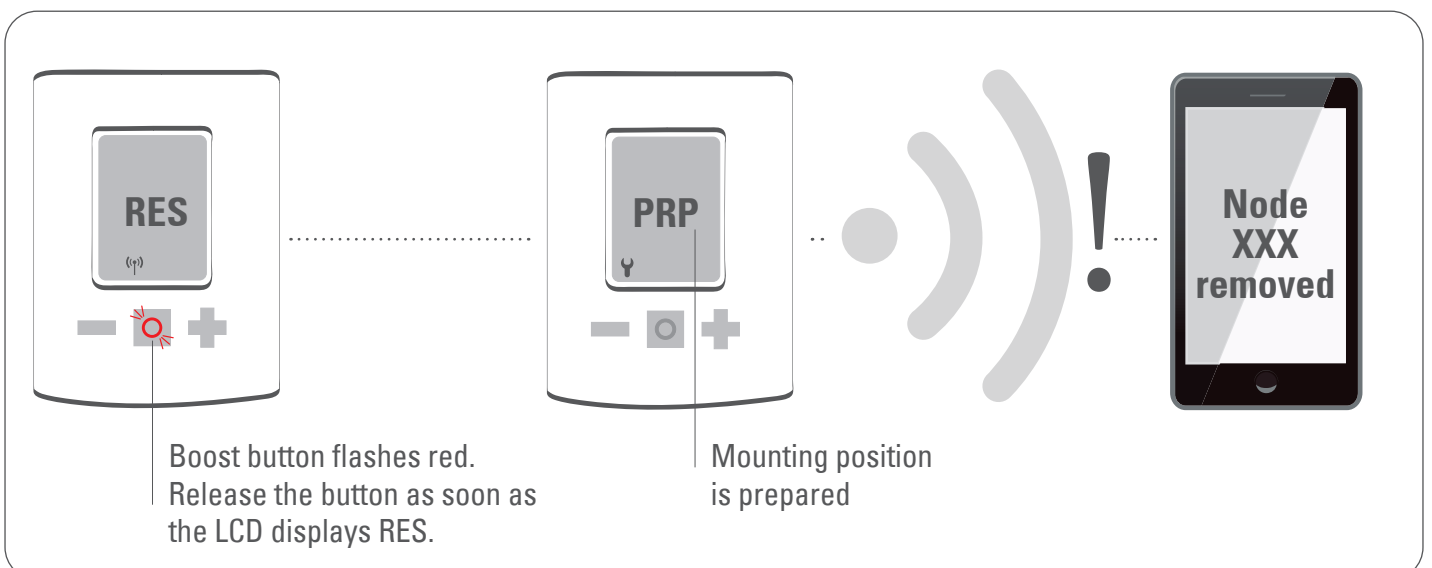

# 5 Local Operation

---

The LCD displays the setpoint temperature if Spirit ZigBee is in thermostat mode or displays pi heating demand if it is in actuator mode.

## 5.1 Setting the target temperature

The target temperature is changed if Plus and Minus button is used.

The changing will cause different setpoint temperature.

Occupied and Unoccupied heating setpoint can only be changed by rf.

The target temperature takes effect 10 seconds after the last entry is made.

The entry range of the target temperature is 5° - 30°C.

Should the temperature be increased above it respectively, the Spirit ZigBee switches to Boost mode.

## 5.2 Activating the child safety lock

The child safety lock can activated/ deactivated by pressing the Plus and Minus button for 3 seconds.

## 5.3 Changing the operating mode

### **Boost mode**

Activate/ deactivate boost mode by pressing Boost button.

As an alternative, you can press the Plus button until ON appears in the display.

### **Comfort mode**

If the device is not in comfort mode, it can be switched to the comfort mode using the Plus or Minus button.

## 5.4 Window open detection

Should the temperature fall suddenly, the window open detection mode is activated. The Spirit ZigBee switches to the OFF mode for 15 minutes.

The window open mode is left automatically after 15 minutes and Spirit ZigBee restore its setpoint temperature.

The sensitivity of the window open detection can be configured.

The window open detection can be terminated at a push of a button.

The window open detection is not executed in the actuator mode (Manufacturer-Specific Mode). The window open detection can be activated/deactivated by an external window contact.

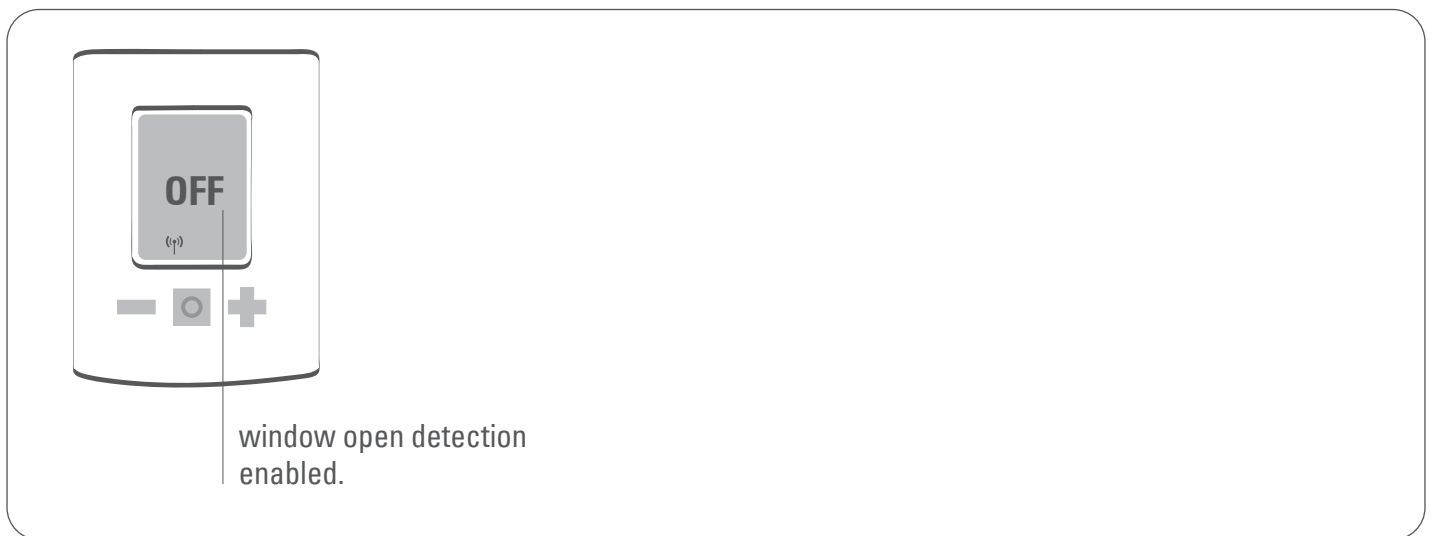

## 6 ZigBee Operation

Cluster	Endpoint	Cluster Id	Server	Client
Basic	1	0x0000	•	
Power Configuration	1	0x0001	•	
Identify	1	0x0003	•	•
Time	1	0x000A		•
Thermostat	1	0x0201	•	•
OTA	1	0x0019		•

## 6.1 Basic

Cluster (Chapter)	Attribute	Attribute Id	Default Value	Data type	Read/Write (R/W)	Manufacturer Specific (Y/N)	Reportable (Y/N)
Basic							
	ZCL Version	0x0000	0x02	0x20 (int8u)	R	N	N
	Application Version	0x0001	App Version	0x20 (int8u)	R	N	N
	Stack Version	0x0002	0x04	0x20 (int8u)	R	N	N
	Hardware Version	0x0003	0x22	0x20 (int8u)	R	N	N
	Manufacturer Name	0x0004	0x1010	0x42 (0-32 byte String)	R	N	N
	Model Identifier	0x0005	SPZBxxxx (xxxx = Application Version)	0x42 (0-32 byte String)	R	N	N
	Date Code	0x0006	YYYYMMDD	0x42 (0-16 byte String)	R	N	N
	Power Source	0x0007	0x03 (battery)	0x30 (8-bit enum)	R	N	N
	Product Code	0x000A	1001 = Eurotronic Spirit ZigBee	0x42 (0-8 byte String)	R	N	N
	SW Build ID	0x4000	00000000	0x42 (0-16 byte String)	R	N	N

## 6.2 Identify

Cluster (Chapter)	Attribute	Attribute Id	Default Value	Data type	Read/Write (R/W)	Manufacturer Specific (Y/N)	Reportable (Y/N)
Identify							
	Identify Time	0x0000	0x0000	0x21 (int16u)	RW	N	N

## 6.3 Power configuration

Cluster (Chapter)	Attribute	Attribute Id	Default Value	Data type	Read/Write (R/W)	Manufacturer Specific (Y/N)	Reportable (Y/N)
Power configuration							
	Battery Percentage Remaining	0x0021	0x00	0x20 (int8u)	R	N	Y
	Battery Size	0x0031	0x03 (AA)	0x30 (8-bit enum)	R	N	N
	Battery Quantity	0x0033	0x02	0x20 (int8u)	R	N	N

## 6.4 Time

Cluster (Chapter)	Attribute	Attribute Id	Default Value	Data type	Read/Write (R/W)	Manufacturer Specific (Y/N)	Reportable (Y/N)
Time							
	No client attributes					N	N

## 6.5 Thermostat

Cluster	Attribute	Attribute Id	Default Value	Data type	Read/Write (R/W)	Manufacturer Specific (Y/N)	Reportable (Y/N)
Thermostat							
	Local Temperature	0x0000		0x29 (int16s)	R	N	Y
	Pi Heating Demand (valve position %)	0x0008	0x00	0x20 (int8u)	R	N	N
	Local Temperature Calibration	0x0010	0x00	0x28 (int8s)	RW	N	N
	Occupied Heating Set point	0x0012	0x7D0 (20°C)	0x29 (int16s)	RW	N	N
	Unoccupied Heating	0x0014	0x7D0 (20°C)	0x29 (int16s)	RW	N	N
	Min Heat Setpoint Limit	0x0015	0x01F4 (5°C)	0x29 (int16s)	R	N	N
	Max Heat Setpoint Limit	0x0016	0x0BB8 (30°C)	0x29 (int16s)	R	N	N
	Remote Sensing	0x001A	0x00	0x18 (8-bit bitmap)	RW	N	N
	Control Sequence of Operation	0x001B	0x02 (Heating only)	0x30 (8-bit enum)	RW	N	N
	System Mode	0x001C	0x04 (Heat)	0x30 (8-bit enum)	RW	N	N
	TRV Mode	0x4000	0x02 (MANU Mode)	0x30 (8-bit enum)	RW	Y	N
	Set Valve Position	0x4001	0x00	0x20 (int8u)	RW	Y	N
	Errors	0x4002	0x00	0x20 (int8u)	R	Y	Y
	Current Temperature Set point	0x4003	0x7D0 (20°C)	0x29 (int16s)	RW	Y	Y
	Host Flags	0x4008	0x000000	0x24 (int24u)	RW	Y	N

## 6.5.1 Application Version Attribute

With every release of the ZigBee microcontroller's firmware the application version attribute will be incremented (e.g. from 0x01 to 0x02). A revision history is provided separately

## 6.5.2 PI Heating Demand Attribute

The attribute can only be read. An unsigned integer is supplied when reading, this representing the current valve position.

**0 = Valve closed**

**255 = Valve opened**

## 6.5.3 Errors

Bit	7	6	5	4	3	2	1	0
Error	reserved	reserved	Valve not Moving (E3)	Valve Movement too slow (E2)	Valve Adaptation Failed (E1)	reserved	reserved	reserved

## 6.5.4 Current Temperature Setpoint

Any value written to Thermostat / Occupied / Unoccupied Heating Setpoint attribute (0x0012 or 0x0014) will automatically be copied to the Current Temperature Set point attribute (0x4003) to allow operating the TRV without the need to be aware of the customer specific attributes.



## 6.6 Attribute Reporting

Device Type	Pre-Configured Reporting Interval	Recommended Reporting Configuration	Cluster	Attribute	Attribute ID
TRV	43200s (12 Hours)	Report twice a day (or not at all)	Power configuration	Battery Percentage Remaining	0x0021
TRV	Report every 1200s	Report every 600s	Thermostat	Local Temperature	0x0000
TRV	Report every 1200s	Report every 600s or on change (or not at all)	Thermostat	Pi Heating Demand	0x0008
TRV	Report every 1200s	Report every 600s or on change (or not at all)	Thermostat	Occupied Heating Setpoint	0x0012
TRV	Report every 1200s	Report every 600s or on change (or not at all)	Thermostat	Unoccupied Heating Setpoint	0x0014
TRV	Report every 1200s or on change	Report every 600s or on change (or not at all)	Thermostat	Errors	0x4002
TRV	Report every 1200s or on change	Report every 600s or on change (or not at all)	Thermostat	Current Temperature Set point	0x4003
TRV	Report every 1200s or on change	Report every 600s or on change (or not at all)	Thermostat	Host Flags	0x4008

# 7 Troubleshooting and Error Messages

---

Problem	Cause	Remedy
Battery icon	Batteries do not have enough power.	Replace the batteries
The radiator does not heat up.	Boiler water temperature O.K? Valve does not open, is it calcified after the summer/heating pause?	Adjust the temperature of the boiler water. Remove the Spirit ZigBee. Move the valve pin back and forth manually/using a tool.
The radiator does not cool down.	The valve does not close completely. It may be that the closing point of your valve seal has shifted.	Remove the Spirit ZigBee. Move the valve pin back and forth manually – perhaps an adaption is not possible because you valve is possibly calcified or the seal no longer performs its function.
Pressure piece falls out.	Due to an endless thread the pressure piece that is situated at the bottom can fall out if the device has not been mounted on the valve.	Remove the batteries from the device. Insert the pressure piece. Insert the batteries.
ER1-3 and ERR	The error message can be cleared by pressing the Boost button.	
ERR	Joining failed.	ZigBee controller not in join mode or out of range.
ER1	No valve detected	Correctly mount the device on the radiator. Use the correct adapter.
ER2	Closing point not detected	Device correctly mounted on the radiator?
ER3	Valve positioning not possible.	Valve pin freely moveable?

# 8 Cleaning

---

## **INFORMATION: RISK OF DAMAGE!**

An incorrect handling of the thermostat can cause damage.

- Do not submerge the thermostat in water or in other fluids.
- Do not use abrasive cleaning agents, brushes with metal or nylon bristles or sharp or metallic cleaning implements such as a knife, a hard spatula etc.
- Clean the thermostat with a soft and dry cloth. Do not apply any pressure to the display.

## 9 Adapter

---

Other adapters are available for all standard valve manufacturers as accessories. Please go to the EUROtronic website: [www.eurotronic.org/service/FAQ](http://www.eurotronic.org/service/FAQ)

## 10 Technical Data

---

Designation	Spirit ZigBee	Mode of application	Type 1
EAN	4260012711233	Dimensions	(W x H x D): 56 x 68 x 89 mm
Article number	700045	Weight	176g (inkl. batteries)
Supply voltage	2 x 1,5V LR6/Mignon/AA	Protection type	IP20
Radio frequency	2,4 GHz	Degree of contamination	2
Transmission power	+8 dBm	Threaded connector	M30 x 1,5mm

## 11 Support and Contact

---

For technical support for EUROtronic products, please contact EUROtronic by email or telephone:

Customer Service:  
Eurotronic Technology GmbH  
Südweg 1  
36396 Steinau-Ulmbach  
Germany

Telephone: +49 66 67 9 1847-19  
Mo.-Fr.: 8:00 - 16:30  
Email: [support@eurotronic.org](mailto:support@eurotronic.org)  
Internet: [www.eurotronic.org](http://www.eurotronic.org)

# 12 Warranty Information

---

The warranty period is 24 months and commences on the date of purchase. Please retain the till receipt as proof of purchase. Defective energy-saving controllers can be sent to the service address below postage paid during the warranty period. We shall then send you a new or a repaired device free of charge. The repair or replacement does not result in the warranty period recommencing from the beginning. Please note that we only provide a warranty for the functioning of the devices and not for the functionality between the thermostat and the bottom part of the valve.

The application-related technical data are exclusively warranted when used with valves from Heimeier, Junkers Landys+Gyr, MNG, Honeywell Braukmann with a thread dimension of M30x1.5, Oventrop (M30x1.5) Danfoss RA, RAV and RAVL. Information on the device combinations is provided on our website ([www.eurotronic.org/Shop](http://www.eurotronic.org/Shop)). When using the thermostat with third party valves/adapters, that are not listed there, the user is to ensure the functionality. EUROtronic shall not provide any warranty services in this case. After expiry of the warranty period, you can also send the defective device to the stated address postage paid. Any repairs that are carried out after expiry of the warranty period incur costs. Your statutory rights are not affected by the warranty.



## Disposing of the thermostat:

(Applicable in the European Union and other European countries with systems for the separate collection of recyclable materials).

**Old devices are not to be disposed of in the household waste!** Should the thermostat no longer be used, each consumer has a **legal obligation to disposing of old devices separate from the household waste**, e.g. by handing them in at a collection point in his municipality/district. This ensures that old devices are professionally utilised and negative impacts on the environment are avoided. This is why electric devices are labelled with the symbol shown here.



## Batteries and rechargeable batteries are not to be disposed of in the household waste!

As a consumer, you have a legal obligation to handing all batteries and rechargeable batteries in at a collection point in your municipality/district or by your retailer, no matter whether they contain harmful substances\* or not so that they can be disposed of in an environmentally friendly manner.

\*Labelled with: Cd = cadmium, Hg = mercury, Pb = lead



## Disposing of packaging materials:

Dispose of the packaging after it has been sorted. Dispose of the cardboard and carton in the waste paper and foil in the recyclable materials.



## Declaration of conformity:

EUROtronic Technology GmbH hereby declares that the Spirit ZigBee radiator thermostat is conform with directive 2014/53/EU. The full text of the EU Declaration of Conformity is available on this website: <https://www.eurotronic.org/produkte/spirit-zigbee.html>.